

ORACLE

# Oracle Maximum Availability Architecture (MAA)

Blueprints for reduced planned and unplanned downtime for the On-Premises, Exadata-based or Cloud-based Oracle AI Database

---

February 2026

# Why is Availability so important?

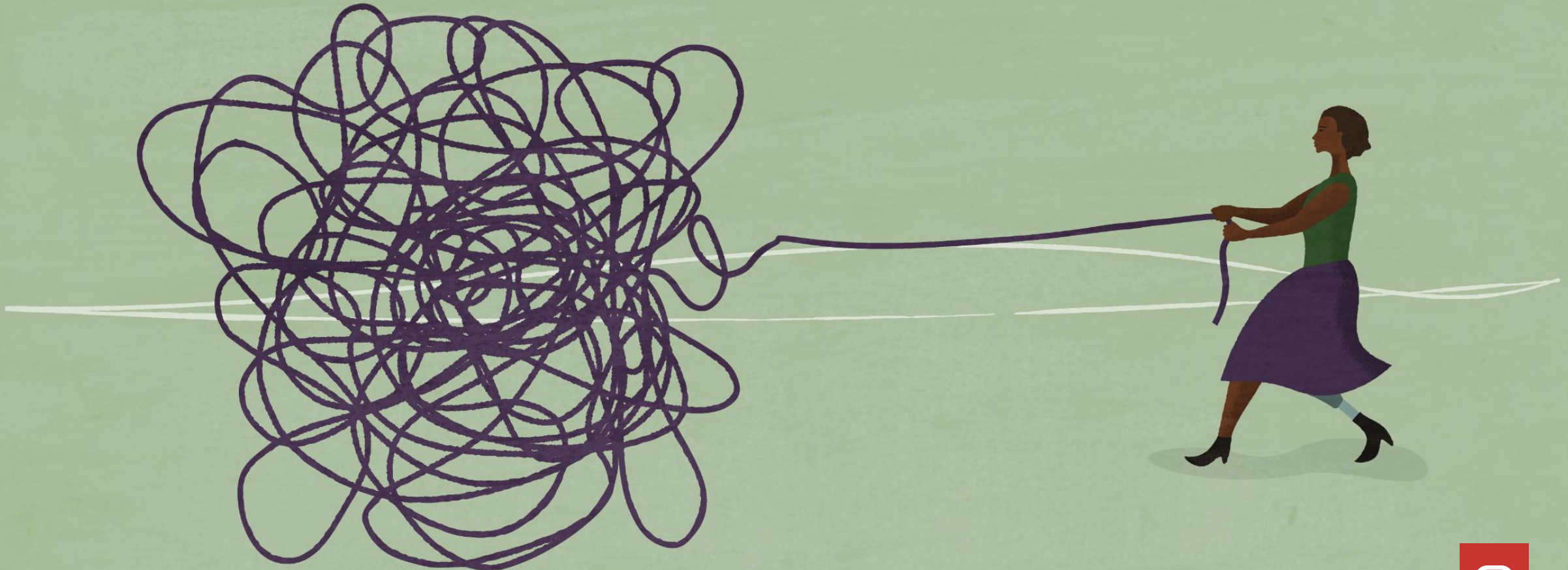

## Impact of downtime



**\$350K**

average cost of  
downtime per hour



**87 hours**

average amount of  
downtime per year



**\$10M**

average cost of  
unplanned data  
center outage or  
disaster



**91%**

percentage of  
companies that  
have experienced  
an unplanned data  
center outage in the  
last 24 months

# Key terminology

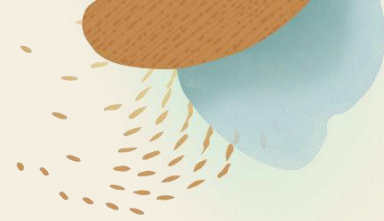

## High availability

A system type with redundant components and enabling software that provides consistent and uninterrupted service, even in the event of hardware or software failures.



## Disaster Recovery

A method of protecting computer systems from failure, in which standby equipment automatically takes over when the main system fails.



## Recovery Time Objective (RTO)

Time to resume application service after failure. The shorter the Recovery Time Objective (RTO) the quicker you get back to business.



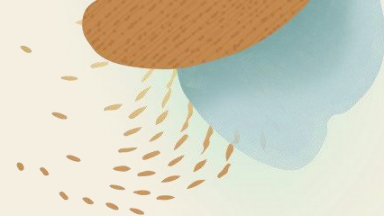

## Recovery Point Objective (RPO)

Tolerance for data loss (sec's, hours, days); impacted by frequency of backups and replication approaches.



# Protect systems during planned and unplanned downtime

Downtime type	Typical causes	Examples
 <b>Planned</b>	System changes Data changes	<ul style="list-style-type: none"><li>• Server changes</li><li>• Database changes</li><li>• Data changes</li><li>• Application changes</li></ul>
 <b>Unplanned</b>	Server failures Data failures	<ul style="list-style-type: none"><li>• Computer failure</li><li>• Storage failure</li><li>• Human error</li><li>• Data corruption</li><li>• Lost writes</li><li>• Hang or slow down</li><li>• Site failure</li></ul>



# MAA & Chaos Engineering – Breaking things to ensure your peace of mind



***Chaos Engineering*** is the art form of experimenting (i.e. proactively breaking things) on a system in order to build confidence in a system's resilience to withstand turbulent events in production

*In today's digital age, this may include but is not limited to:*

- Network, server & storage failures
- Human errors & data corruption
- Data corruption
- Power failures or site failure (i.e. *Godzilla attack or hurricane*)
- Application, database & server software updates
- Data reorganization or changes
- Application changes and optimizations

# Oracle Solutions for High Availability and Disaster Recovery

—  
Maximum Availability Architecture

# Next Gen Maximum Availability Architecture (MAA)

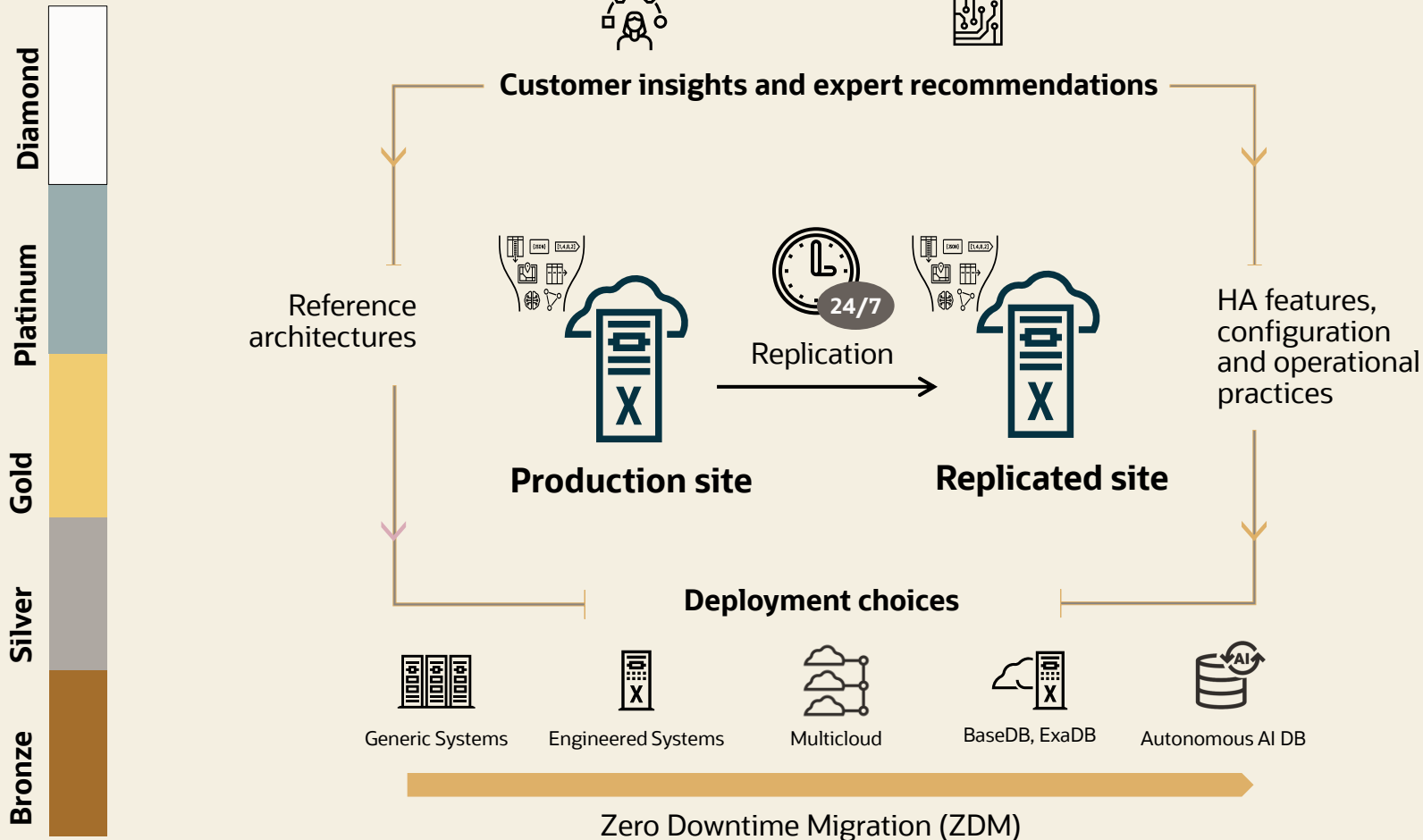

Diamond  
Platinum  
Gold  
Silver  
Bronze

**High performance**

Resource Management    Database In-Memory    True Cache

**Continuous availability**

Application Continuity    Online Redefinition    Edition-based Redefinition

**Data protection**

Flashback    RMAN    ZDLRA+ ZRCV

**Active replication**

Active Data Guard    Full Stack DR    GoldenGate

**Scale out & Lifecycle**

RAC    Globally Distributed AI Database    FPP    Real Application Testing





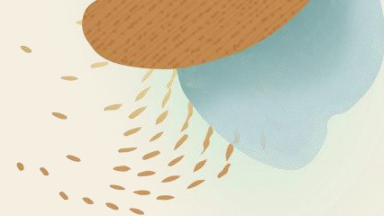

# Next-Gen MAA Reference Architectures

## Availability service levels for the next generation of Oracle AI Database

### Bronze

### Silver

### Gold

### Platinum

### Diamond (NEW)

#### Dev, test, prod

#### Prod/departmental

#### Business critical

#### Mission critical

#### Extreme availability

#### Bronze +

#### Silver with RAC +

**Gold with Exadata and either:**

#### Configuration

Single instance DB

Database HA with RAC or Local Data Guard

DB replication with (Active) Data Guard with automatic failover

Option 1 - GoldenGate with Oracle Database 19c

GoldenGate 26ai replicas, *each running:*

Restartable

Client failover HA best practices

OR

Oracle AI Database 26ai

Backup/restore

Application Continuity (optional)

Client failover DR best practices

Option 2- (Active) Data Guard with Oracle AI Database 26ai

+ RAC on Exadata  
+ (Active) Data Guard



Recoverable local failure: Minutes to hour  
Disasters: Hours to days  
RPO < 15 min

Recoverable local failure: seconds to minutes  
Disasters: Hours to days  
RPO < 15 min

Recoverable local failure: Less than 60 seconds  
Disasters: < 5 min  
RPO = zero or near zero

Recoverable local failure: Less than 20 seconds  
Disasters: < 1 min  
RPO = zero or near zero

Recoverable local failures: Less than 10 seconds  
Disasters zero to 10 secs  
RPO = zero or near zero



# MAA, has you covered, no matter where your apps reside

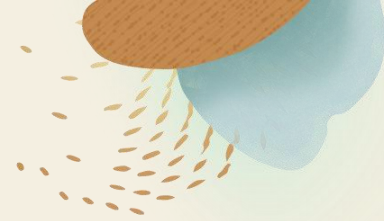

On-premises, on commodity hardware, or on engineered systems like Exadata

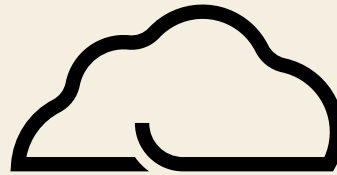

In Oracle Cloud Infrastructure, using services such as the Autonomous AI Database or Exadata Database Cloud



In hybrid and multicloud environments; e.g. Oracle AI Database@Azure, Oracle AI Database@Google Cloud, or Oracle AI Database@AWS



# Examples and benefits of MAA everywhere and anywhere....

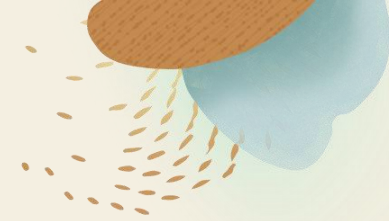

## Generic Systems:

- MAA Reference architectures (bronze through platinum)
- MAA configuration and operational best practices for all tiers
- MAA database compliance and health checks (i.e. Orachk)

## Engineered Systems:

- Fully integrated end-to-end MAA best practices including DB, OS, network, storage
- Designed for lowest brownout, best performance, QoS, and highest data protection, agility, and availability
- Specialized hardware designed for the highest availability, resiliency and performance
- Fully MAA compliant OOTB with Exachk for full stack compliance and health checks

## Exadata Database Cloud in OCI or Multicloud

- Cloud automation deploys and manages the database architecture
- MAA operational and configuration best practices are automated and built-in
- Collaboration with Azure, Google, AWS providing MAA in multicloud
- Multi-cloud MAA evaluations

## Autonomous AI Database in OCI or Multicloud

- Fully managed MAA-compliant architecture and configuration
- Simplified deployment, operations, and Oracle-managed maintenance

# Oracle AI Database MAA Availability Recent Features



Rolling Patching for  
Complex Changes



Globally Distributed  
DB with RAFT



Single Server  
Rolling Database  
Maintenance



DBMS\_ROLLING with  
Application Continuity



FPP Local Mode



Exadata  
Fleet Update



In-Database Firewall



Data Guard Redo  
Decryption for Hybrid  
DR Configurations

# Oracle AI Database 26ai MAA Scalability Recent Features

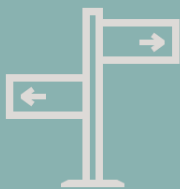

RAC Smart Connection  
Load Balancing



True Cache



Real-time Query for  
PDB Standby



Clusterware  
Resiliency



Ordered Sequences  
with Oracle RAC

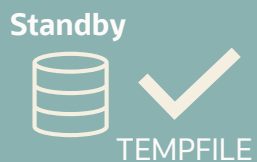

Automatic tempfile  
creation on the  
standby database



Oracle RAC Fast Start  
Reconfiguration



RDMA-based  
Exadata RAC Scaling



# Thousands of Oracle customers making use of MAA

—  
Maximum Availability Architecture

# Thousands of critical deployments use MAA, on-premises and cloud

76% of Fortune Global 100 run Exadata | 53% run Exadata Cloud

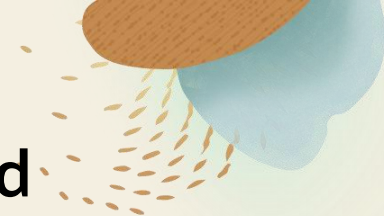

Superior architecture for ALL workloads

- Petabyte warehouses
- Super critical systems
  - Financial trading
  - Process manufacturing
  - E-commerce
- Packaged applications
  - SAP, Oracle, Siebel, PSFT, ...
- Database consolidation



# Diving into the MAA tiers

—  
Maximum Availability Architecture



# BRONZE

Dev, Test, Prod - Single Instance or Multitenant Database with Backups

- Single Instance with Clusterware Restart
- Advanced backup/restore with RMAN
  - Optional ZDLRA with incremental forever and near zero RPO
- Storage redundancy and validation with ASM
- Multitenant Database/Resource Management with PDB features
- Online Maintenance
- Some corruption protection
- Flashback technologies

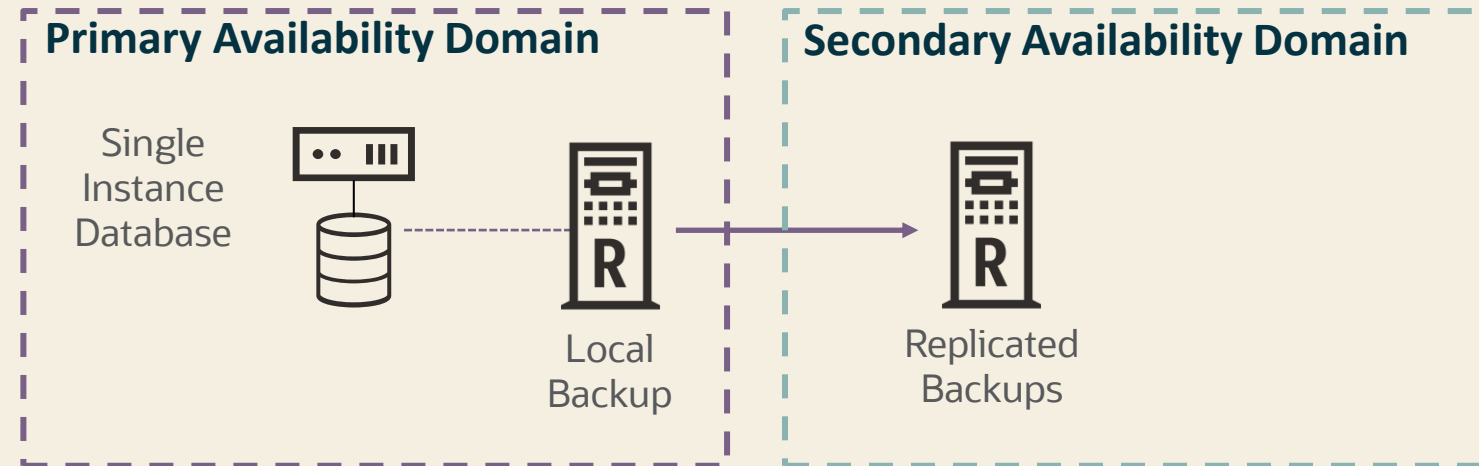

## Outage Matrix

Unplanned Outage	RTO / RPO Service Level Objectives (f1)
Recoverable node or instance failure	Minutes to hour
Disasters: corruptions and site failures	Hours to days. RPO since last backup or near zero with ZDLRA
Planned Maintenance	
Software/hardware updates	Minutes to hour (f1)
Major database upgrade	Minutes to hour

f1: RPO=0 unless explicitly specified





# Oracle Clusterware for Automatic Restart

1. Oracle Clusterware is available for all Oracle AI Databases
  2. Enables HA capabilities and resource management:
    - Automatic Restart of database instances, listeners, and other resources
    - Fleet patching
    - Service management, including restarting service after failure
    - Automatic Storage Management (ASM) for HA, data protection and ease of use
- Trade off: additional software maintenance for Grid Infrastructure





# Advantages of Multitenant Architecture

Isolation and agility with economies of scale

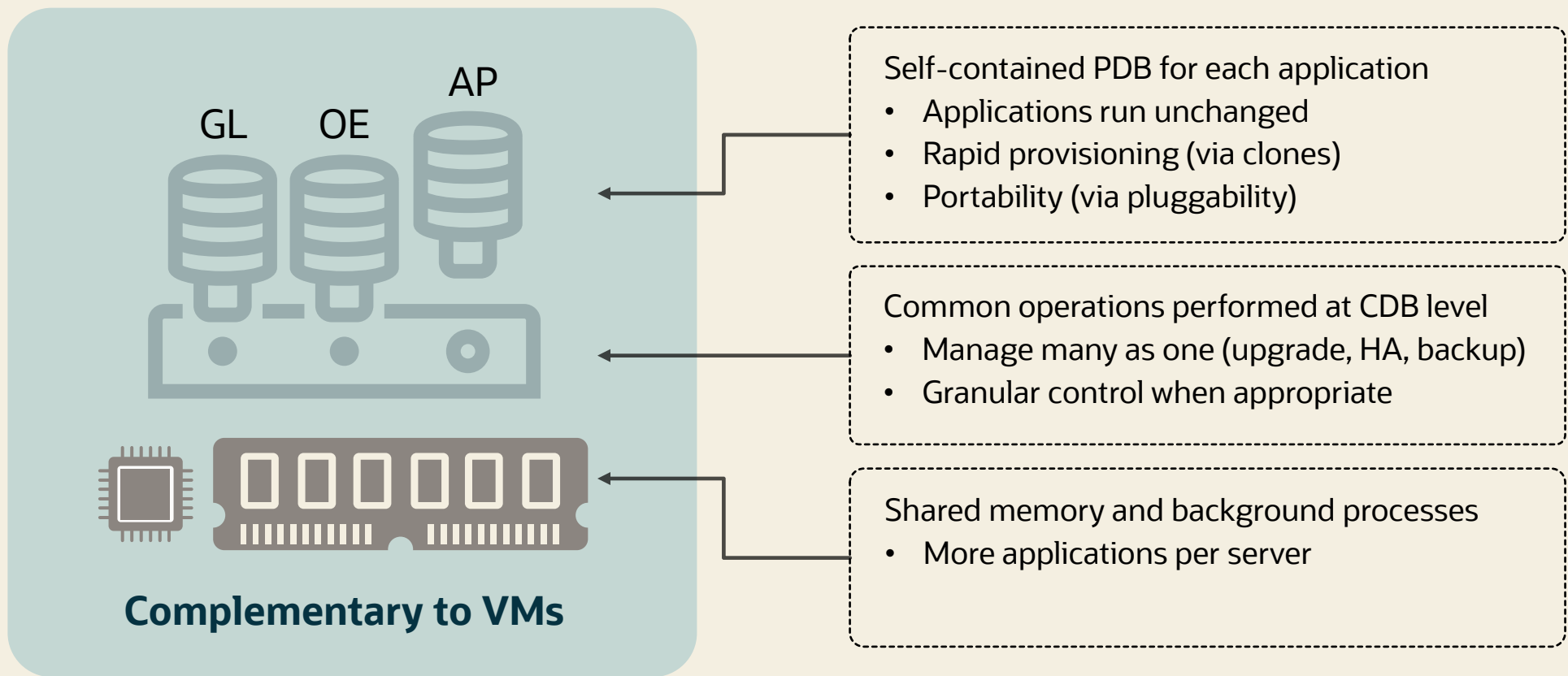

# Oracle Multitenant Features



## Rapid cloning and provisioning

- Local clones and remote clones
- Snapshot clones
- Refreshable PDBs



## Manage many as one

- Database consolidation
- Improve productivity
- Maintain granular control



## Improve agility for development teams

- Pre-configured service level agreement
- Compatibility
- Interface



## Enhance security

- Separation of duties
- Data security
- Resource isolation



## Integration with Oracle RAC

- High availability
- Scalability
- Flexibility





# Pluggable Database Backup, Restore and Recovery

- Backup and restore pluggable database ...
- Create Restore Point 'before\_event' for pluggable database...
  - Normal or Guaranteed Restore Point
  - Clean Restore Point
- Flashback Pluggable Database
- Complete ZDLRA support



# Oracle Recovery Manager - RMAN

## Database Integrated Backup and Recovery

- Unique knowledge of database file formats and recovery procedures
  - Oracle block validation
  - Online block-level recovery
  - Native encryption, compression
  - Table/partition-level recovery
  - Oracle Multitenant support
- Tape and cloud backups
- Unified Management

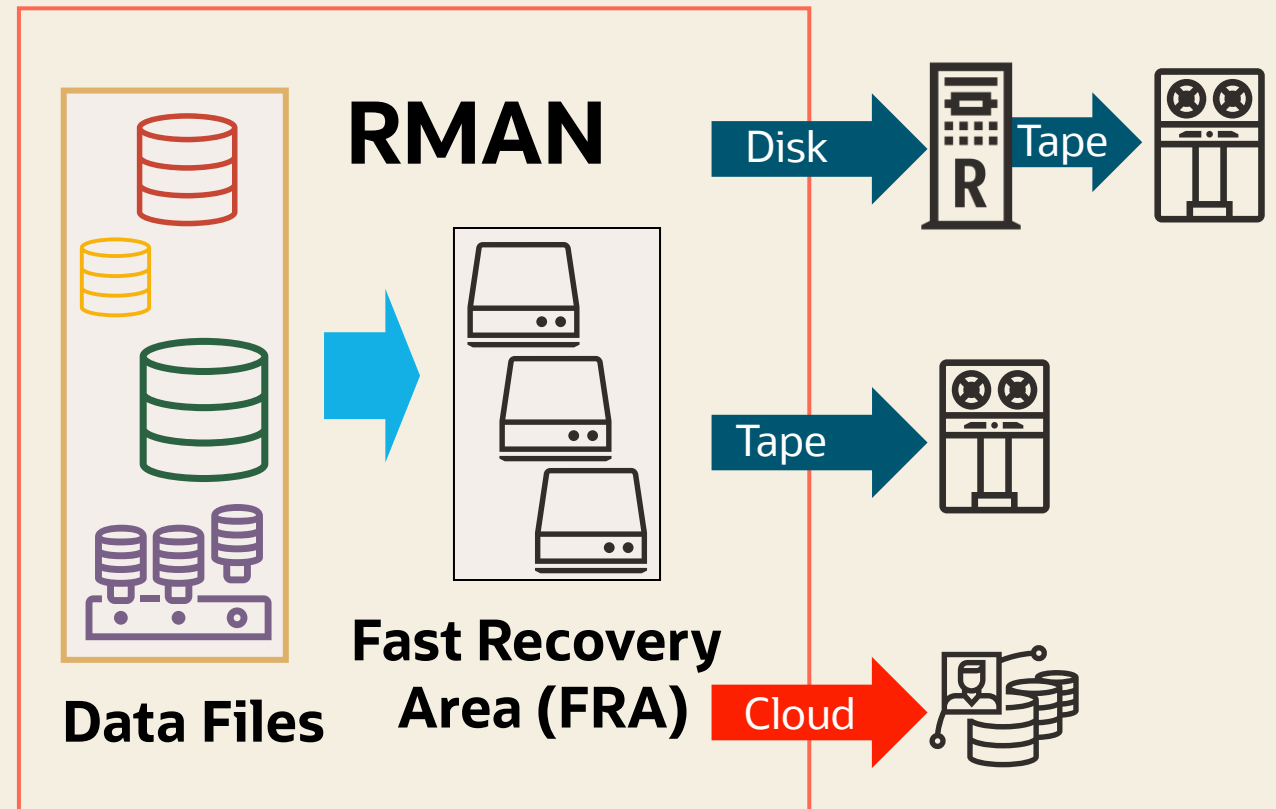



# RMAN Enhancements for Table Recovery

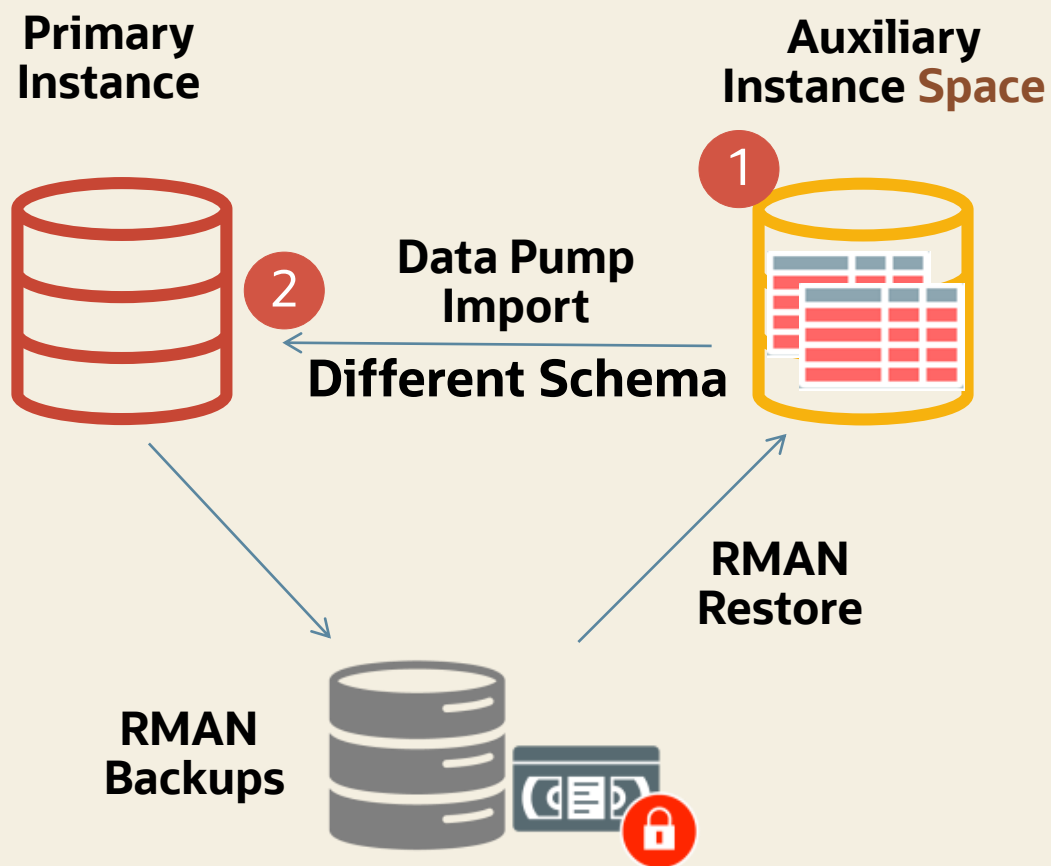

- 1) Check Auxiliary Instance Disk Space
  - Automated Table Recovery requires disk space for SYSTEM, SYSAUX, UNDO and User Tablespace(s)
  - Pre-check for space in the Auxiliary Instance disk space to avoid failures in the middle of the process
- 2) Recovery Across Schema
  - Enables Table level recovery under different schema
  - Provide **OLD: NEW Schema(s)** under **REMAP TABLE**

```
RECOVER TABLE hr.department, sales.product  
UNTIL SCN 1234 AUXILIARY DESTINATION  
' /tmp/' REMAP TABLE  
hr.department:dev.testdepartment,  
sales.product:mkt.newproduct;
```



# Recovery Appliance Recommended

Continuous data protection and multi-tiered backup addressing compliance requirements

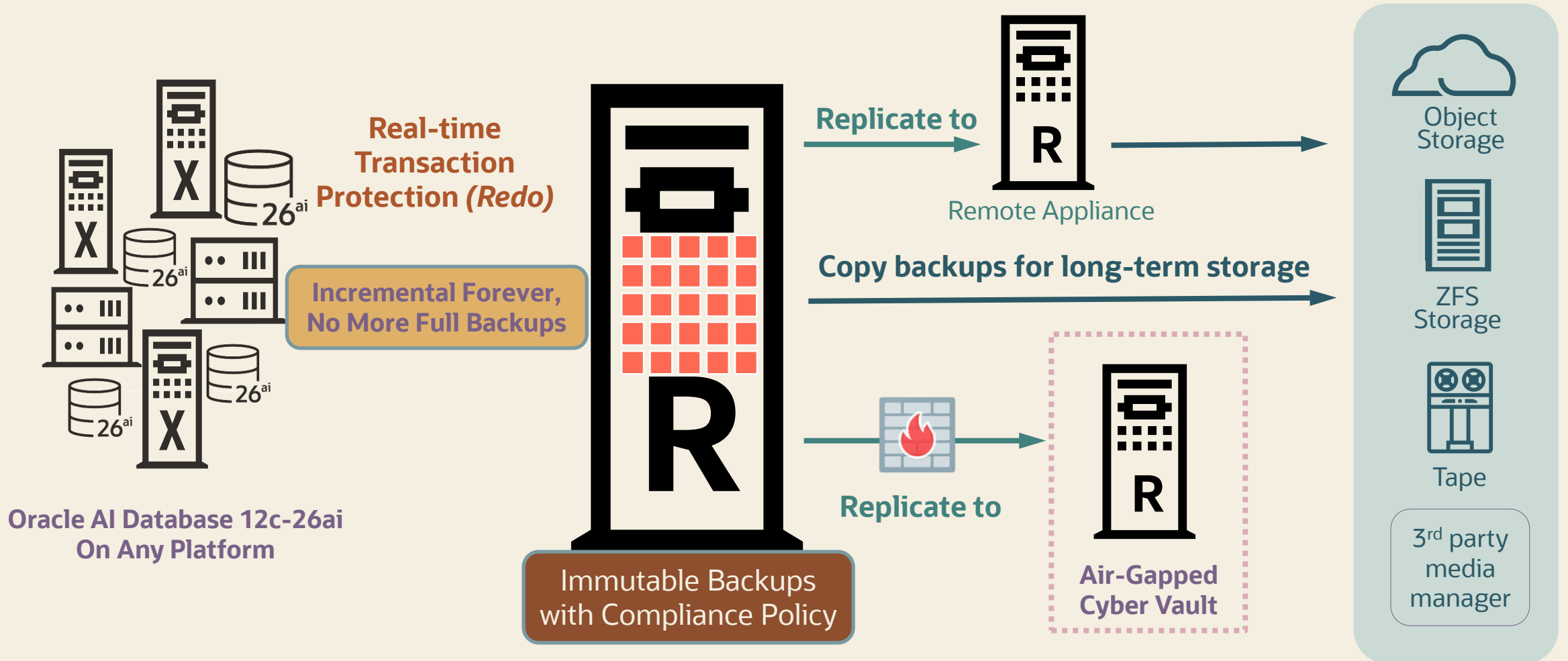





# Database and Exadata Health Checks

## Assessment Report

- Health Score, Summary, Findings

## Findings & Recommendations

- How to Solve the problem?

## MAA Score Card

- MAA architectural readiness and configuration practices

**Oracle Exadata Assessment Report**

**System Health Score is 89 out of 100 (detail)**

**Cluster Summary**

Cluster Name	cluster-clu1
OS/Kernel Version	LINUX X86-64 OELRHEL 5.2.6.39-400.124.1.el5uek
CRS Home - Version	/u01/app/11.2.0.4/grid - 11.2.0.4.1
DB Home - Version - Names	/u01/app/oracle/product/11.2.0.4/dbhome_1 - 11.2.0.4.1 - dbm
EM Agent Home	/u01/app/oracle/em/agent_haem/core/12.1.0.5.0
Exadata Version	11.2.3.3.0
Number of nodes	9
Database Servers	2
Storage Servers	3
IB Switches	4
exachk Version	12.1.0.2.6(BETA).20160125
Collection	exachk_randomadm07_dbm_012516_141503.zip
Duration	10 mins, 49 seconds
Executed by	root
Collection Date	25-Jan-2016 14:15:39

*Note! This version of exachk is considered valid for 120 days from today or until a new version is available*

*NOTE : exachk is only one part of the MAA Best Practices recommendation methodology. My Oracle Support "Oracle Exadata Best Practices (Doc ID 252552.1)" should be reviewed thoroughly as it is the driver for exachk and contains additional operational and diagnostic guidance that is not programmed within exachk.*

*WARNING! The data collection activity appears to be incomplete for this exachk run. Please review the "Killed Processes" and / or "Skipped Checks" section and refer to "Appendix A - Troubleshooting Scenarios" of the "Exachk User Guide" for corrective actions.*

**Database Server**

Status	Type	Message	Status On	Details
FAIL	SQL Parameter Check	ASM parameter SGA_TARGET is NOT set according to recommended value.	All Instances	<a href="#">View</a>
WARNING	Patch Check	Patch 16618055 not is applied on RDBMS_HOME	All Homes	<a href="#">View</a>
WARNING	OS Check	Database parameter _enable_NUMA_support should be set to recommended value	All Database Servers	<a href="#">Hide</a>

**Verify database parameter \_enable\_NUMA\_support**

<b>Recommendation</b>	NUMA enabled in the database on all Exadata 8 socket servers boosts overall application performance. NUMA enabled in the database on Exadata generation X5 2 socket servers boosts performance of memory scan intensive workloads, for example IMDB.
<b>Needs attention on</b>	randomadm07
<b>Passed on</b>	-

**Status on randomadm07:**  
**WARNING =>** Database parameter \_enable\_NUMA\_support should be set to recommended value

DATA FROM RANDOMADM07 - DBM DATABASE - VERIFY DATABASE PARAMETER \_ENABLE\_NUMA\_SUPPORT

```
_enable_NUMA_support = FALSE
isdefault = FALSE
```

INFO	SQL Check	Direct NFS Client is NOT enabled	All Databases	<a href="#">View</a>
------	-----------	----------------------------------	---------------	----------------------

**Maximum Availability Architecture (MAA) Scorecard**

Outage Type	Status	Type	Message	Status On	Details	
			<b>Description</b> Proactive hardware and software maintenance helps avoid critical issues and helps maintain the highest stability and availability of your system. By running the latest version of exachk, automatic detection occurs for the following:  1. Software version mismatches on the system. 2. Known critical issue exposure for your specific environment. 3. Software releases that are older than recommended versions.  Furthermore, the suggested "Recommended Versions" can be leveraged when planning for your next planned maintenance window. Note that not all Exadata Software components need to be upgraded during one planned maintenance window; however it is advised to maintain a regular maintenance schedule. The recommended frequency is 3 to 12 months depending on business requirements. Oracle recommends patching and upgrading in the following order:  1. Grid Infrastructure Software and Oracle Database Software. Grid Infrastructure should always be equal to or higher than the highest Oracle Database Software version. 2. Exadata Database Server Software. For Exadata Database Server Software upgrades, run and evaluate exachk and dbnodeupdate precheck outputs. 3. Exadata Storage Server Software. For Exadata Storage Server Software upgrades, run and evaluate exachk and patchmgr precheck outputs. 4. InfiniBand Switch Software. For InfiniBand Switch Software upgrades, run and evaluate exachk and patchmgr precheck outputs.			
	FAIL	SOFTWARE MAINTENANCE BEST PRACTICES	<b>Best Practices</b> 1. Note: 1662016.1 - Oracle Sun Database Machine Cross Node Consistency Best Practice Checks 2. MAA Best Practices for Database Consolidation and Oracle Multitenant with Oracle 12c 3. Oracle Exadata Software Planned Maintenance 4. Note: 1461240.1 - Exadata Database Machine Software and Hardware Maintenance Planning Guide 5. Best Practices For Database Consolidation On Exadata Database Machine 6. Note: 155276.1 - Database Machine and Exadata Storage Server Supported Versions 7. Note: 1270094.1 - Exadata Critical Issues			
	FAIL	OS Check	System is exposed to Exadata critical issue DB24	All Database Servers	<a href="#">View</a>	
	FAIL	Patch Check	System is exposed to Exadata critical issue DB28	All Homes	<a href="#">View</a>	
	FAIL	Storage Server Check	System is exposed to Exadata Critical issue EX19	All Storage Servers	<a href="#">View</a>	
		<b>Component</b>	<b>Host/Location</b>	<b>Found version, Recommended versions</b>	<b>Status</b>	
		Database Home	randomadm07,randomadm08 /u01/app/oracle/product/11.2.0.4/dbhome_1	11.2.0.4.1 11.2.0.4.160119	11.2.0.4 BP is older than recommended.	
		Grid Infrastructure	randomadm07,randomadm08 /u01/app/11.2.0.4/grid	11.2.0.4.1 11.2.0.4.160119	11.2.0.4 BP is older than recommended.	
		Exadata	randomadm07,randomadm08	11.2.3.3.0 12.1.2.1.3 or 12.1.2.2.1	Older than recommended version.	
		STORAGE SERVER	Exadata	randomcladm12,randomcladm13,randomcladm14	11.2.3.3.0 11.2.3.3.1	Older than recommended version.
		IB SWITCH	Firmware	randomsw-iba0	2.1.8.1 2.1.5.1 or higher	Version within recommended range. Exception: Version is different from peers.
			randomsw-iba0,randomsw-iba0,randomsw-iba0	2.1.3.4 2.1.5.1 or higher	Version within recommended range. Exception: Version is different from peers.	

Note: Automated Orachk/Exachk Healthcheck MOS 107954.1 updated frequently





# Online Operations

Redefine your data structures without taking tables offline

- Online Redefinition: reorganize and redefine tables online
  - Examples:
    - add/drop/rename/reorder columns
    - change physical storage structures
- Updates / queries not interrupted
- Resumes at point of any failure
- Ability to enable fast rollback to prior definition if needed
- Ability to monitor progress throughout redefinition operation

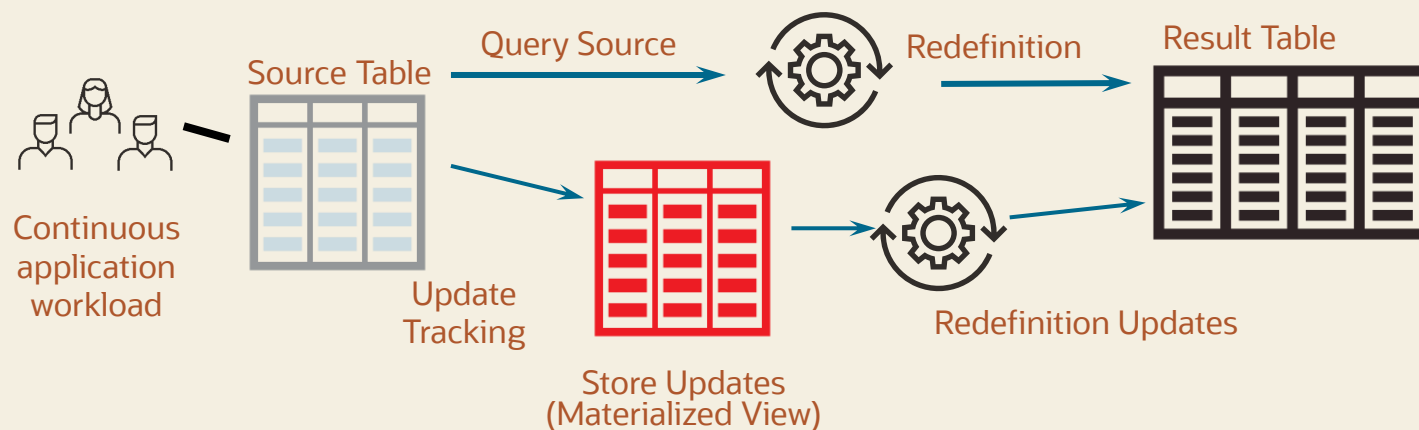



# Flashback Technologies

## Rewind Button for Oracle AI Databases

- Fast point-in-time recovery (PITR) without expensive restore operation
- Error investigation
  - View data as of previous point in time
- Error correction
  - Back-out a transaction
  - Incorrect table updates
  - Rewind the entire database
- *New in Oracle AI Database 26ai:*
  - Flashback Time Travel operates at the transactional level tracking and archiving transactional changes to tables

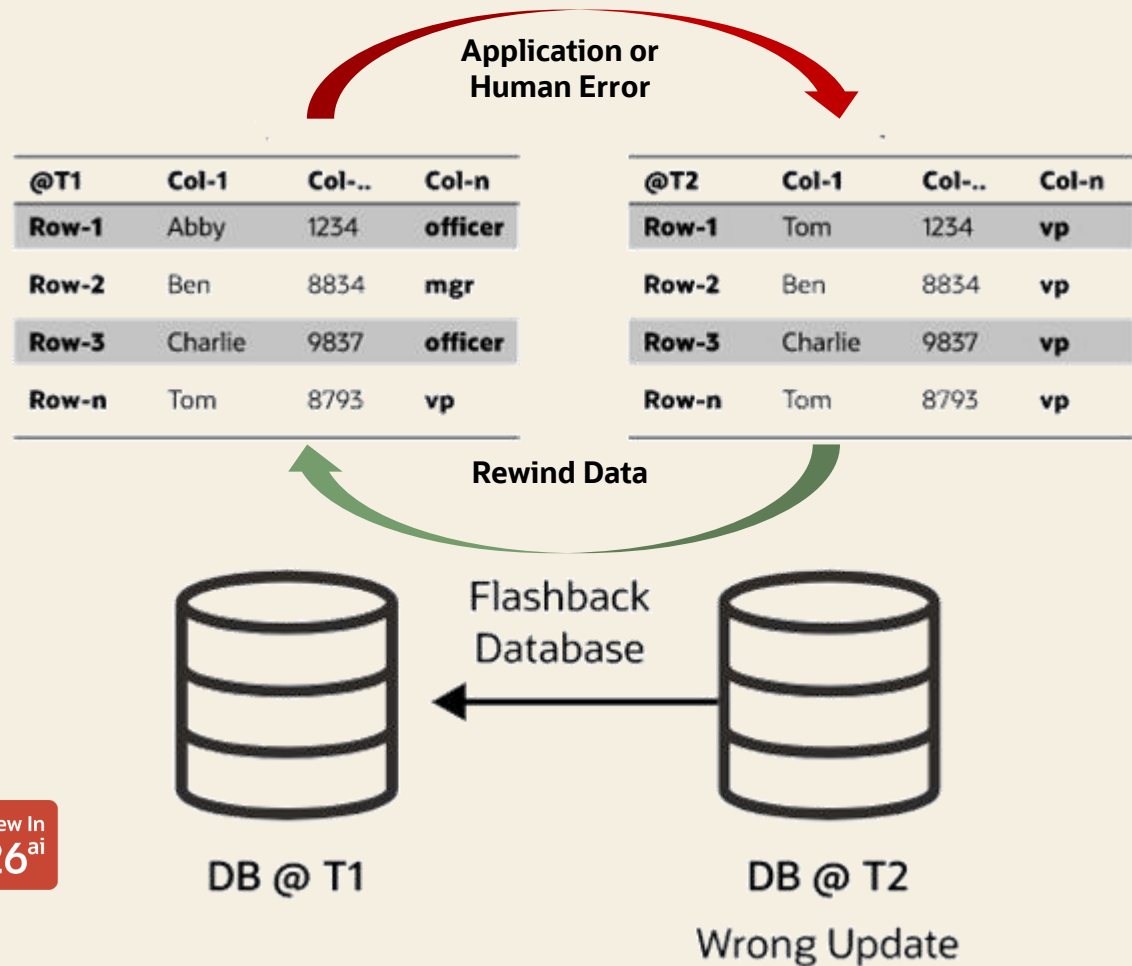

New In  
26<sup>ai</sup>



# SILVER (Option 1)

## Prod/Departmental

### Bronze +

- Real Application Clustering (RAC)
- Application Continuity
- Globally Distributed Database (Optional)
  - Provides fault isolation, scalability, and geographical distribution

Client connectivity best practices:  
<https://docs.oracle.com/en/database/oracle/oracle-database/26/haovw/continuous-availability-applications.html>

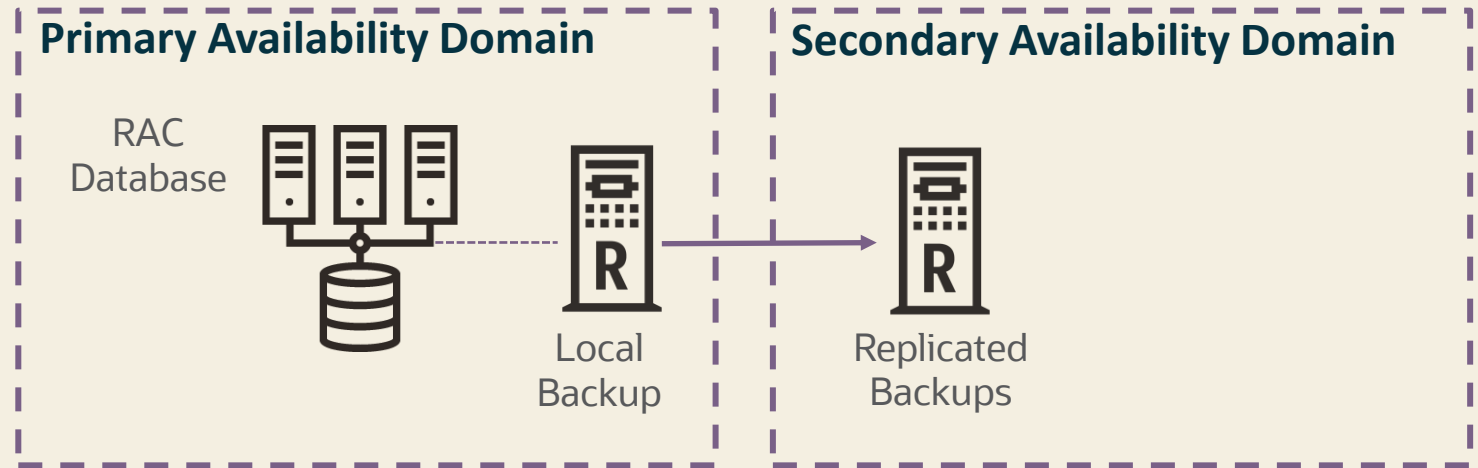

## Outage Matrix

### Unplanned Outage

Recoverable node or instance failure

Disasters: corruptions and site failures

### RTO/RPO Service Level Objectives(f1)

**<30 seconds (f2)**; single-digit minutes on non-Exadata

Hours to days. RPO since last backup or near zero with ZDLRA

### Planned Maintenance

Software/Hardware updates

**Zero** (f1)

Major database upgrade

Minutes to hour

f1: RPO=0 unless explicitly specified

f2: Fast sub-30 seconds role transition is on Exadata; near-zero with Application Continuity enabled.



# Oracle RAC (Real Application Clusters)

Active-active instances provide unmatched scalability, performance and availability

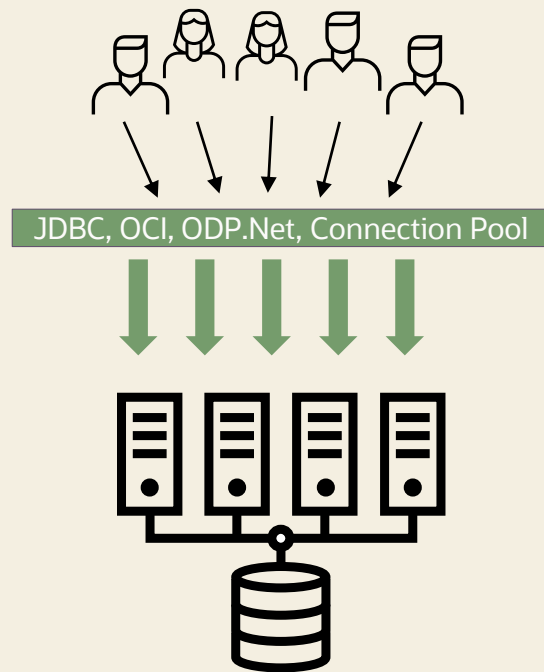
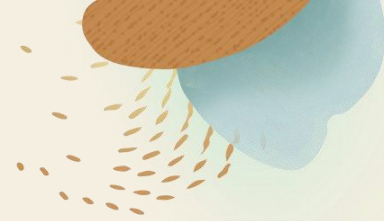

- ✓ Unique scale-everything, highly available database architecture with concurrent active active instances
- ✓ Scales OLTP, OLAP, and Hybrid Workloads and minimizes downtime with rolling patching
- ✓ Applications supported on single instance runs without any changes on Oracle RAC
- ✓ Applications scale by simply adding nodes to the cluster without incurring downtime



# Oracle RAC 26ai Improvements

**Parallel** operations result in consistent performance

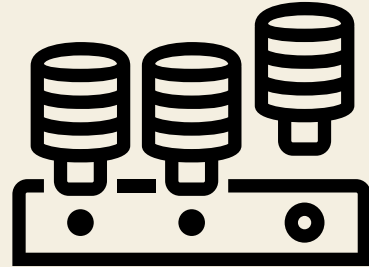

**2X** faster Pluggable Database Open

Parallel Distributed Lock Manager operations during PDB open



**8X** faster to create 10k services

**14X** faster to create, **23X** faster to delete individual services with 10k services

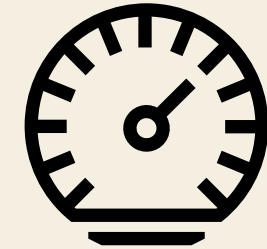

**10X** Faster start of work on instance crash or restart

Buddy Instance, Parallel operations on dirty buffers list and other features

# Distribute Vector AI and OLTP workloads on Oracle RAC Instances

Realtime insights without interrupting or slowing business operations

## Integrate AI Vector Search with Business Data

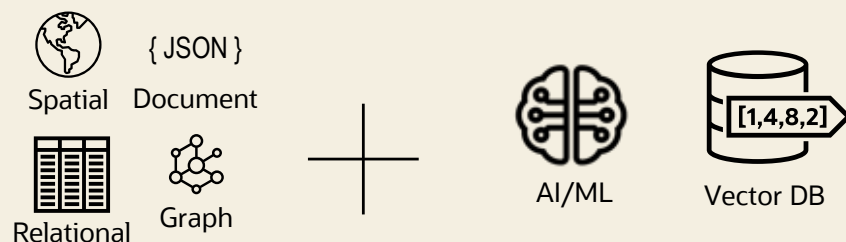

**Best of both:** Isolate ongoing Business operations on one set of instances while running RAG workloads on another

- Integrate AI Vector search on business-critical data with simple-to-use SQL that can benefit from both inter-node and intra-node parallel operations.
- Active-Active Oracle RAC
  - Protects against outages due to hardware failures
  - Scales performance as workloads can run concurrently on different Oracle RAC instances
- Even better performance, scalability and high availability on Engineered Systems such as Exadata

# Performance of sample AI Vector Search workload on Oracle RAC

Data Set: GloVe-25 | ~1.2 million rows ( VECTOR(25, FLOAT32 )

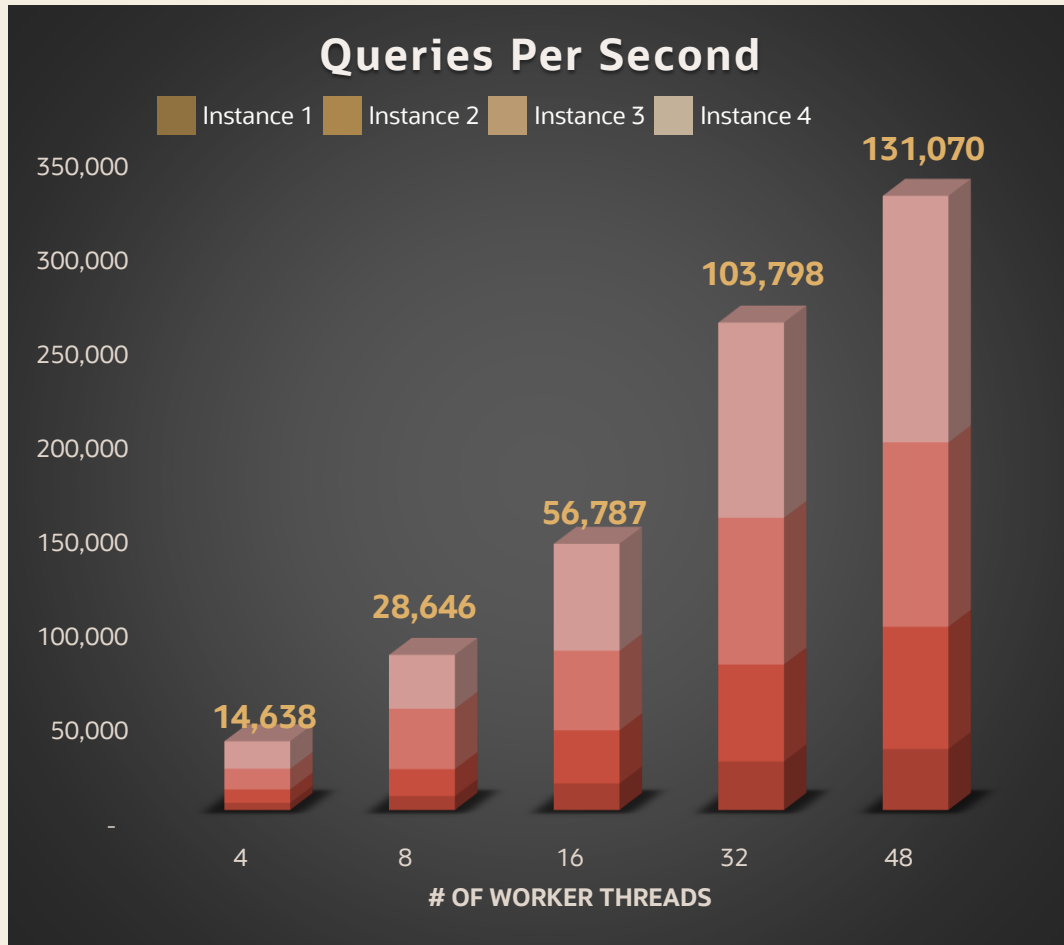
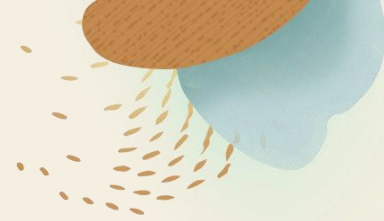

- Oracle RAC scales the GloVe-25 workload linearly across all the instances
  - The GloVe-25 dataset contains pre-trained, 25-dimensional word vectors generated using the GloVe (Global Vectors for Word Representation) algorithm
  - Each entry maps a single English word to a compact numerical representation based on semantic similarity
  - ~99% of the query elapsed time was CPU time







# Transparent Application Continuity (TAC)

Keeps applications online during outages without requiring any custom error handling

- Hide downtime from end-users
  - TAC rebuilds the session state and replays in-flight transactions as part of automated session failover
- Eliminate errors unless unrecoverable
  - For both planned maintenance and unplanned outages
- Fast Application Notification (FAN) and session draining
  - FAN notifies clients of database status changes - helps break applications out of TCP timeouts
  - Draining causes sessions to complete their work on a given instance to prepare the node or the database for maintenance - no application changes required
- Best used with an Oracle (compatible) connection pool
- Oracle AI Database 26ai provides Application Continuity through DBMS\_ROLLING operations.

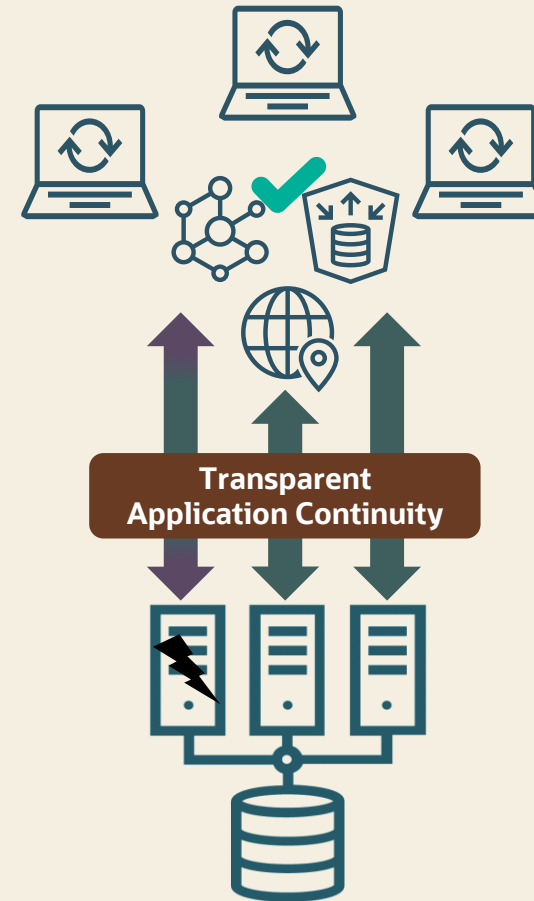

New In  
26<sup>ai</sup>





# Fleetwide maintenance on-premises and for ExaDB in OCI

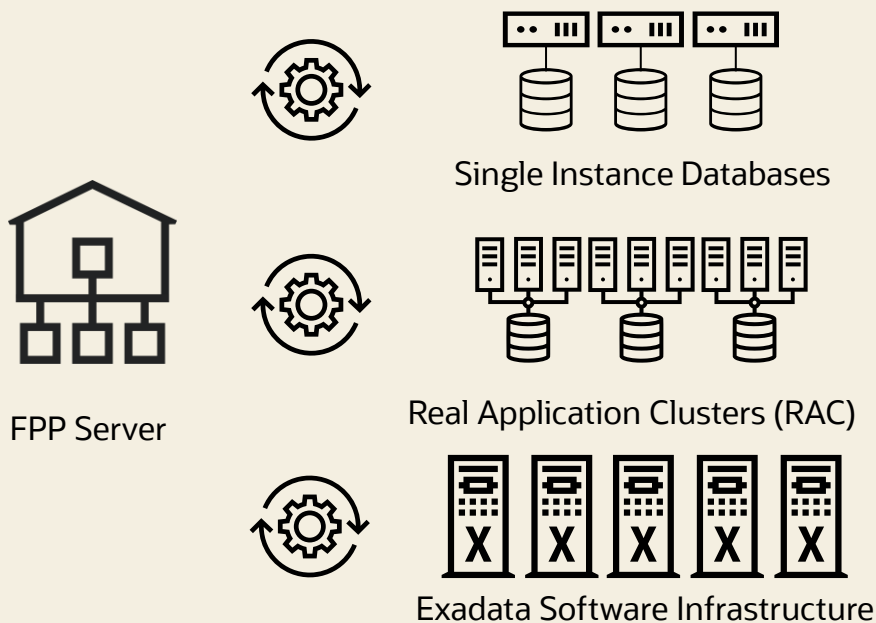

## Fleet Patching & Provisioning:

- Gold image-based drift detection
- Integrated job scheduling
- User actions for extensibility
- Comprehensive Exadata Patching
- Full-stack Exadata patching



Exadata Fleet Update

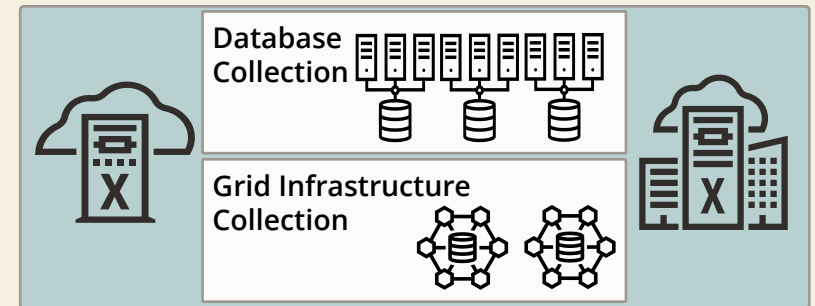

## Exadata Fleet Update:

- Group multiple Oracle AI Databases and Oracle Grid Infrastructures into collections
- Rolling and non-rolling, session draining, scheduling of pre-check, staging, and patch operations
- Less complexity with out-of-place patching mechanism
- Available for ExaDB-D and ExaDB-C@C deployments



# SILVER (Option 2)

## Prod/Departmental

### Bronze +

- Local Standby Database using Data Guard
  - Protects from local failures but minimal benefits for planned maintenance
- Globally Distributed Database (Optional)
  - Provides fault isolation, scalability, and geographical distribution

Client connectivity best practices:

<https://docs.oracle.com/en/database/oracle/oracle-database/23/haovw/continuous-availability-applications.html>

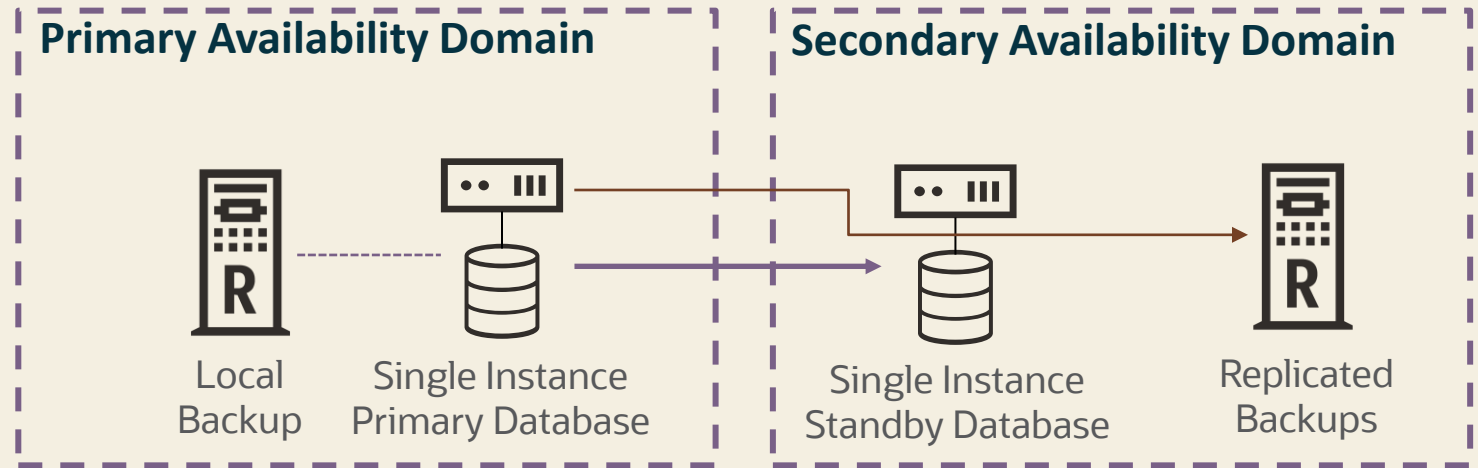

## Outage Matrix

Unplanned Outage	RTO/RPO Service Level Objectives <sup>(f1)</sup>
Recoverable local failure	<b>&lt; 1 min</b>
Disasters: corruptions and site failures	Hours to days. RPO since last backup or near zero with ZDLRA
Planned Maintenance	
Software/Hardware updates	Minutes to hour (f1)
Major database upgrade	Minutes to hour

f1: To achieve minimal downtime or lowest impact, apply application client best practices; Batch jobs should be deferred outside planned maintenance window.



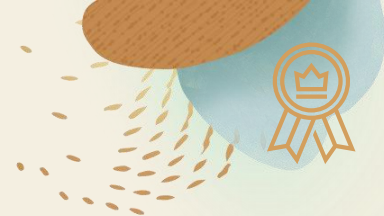

# Oracle Data Guard

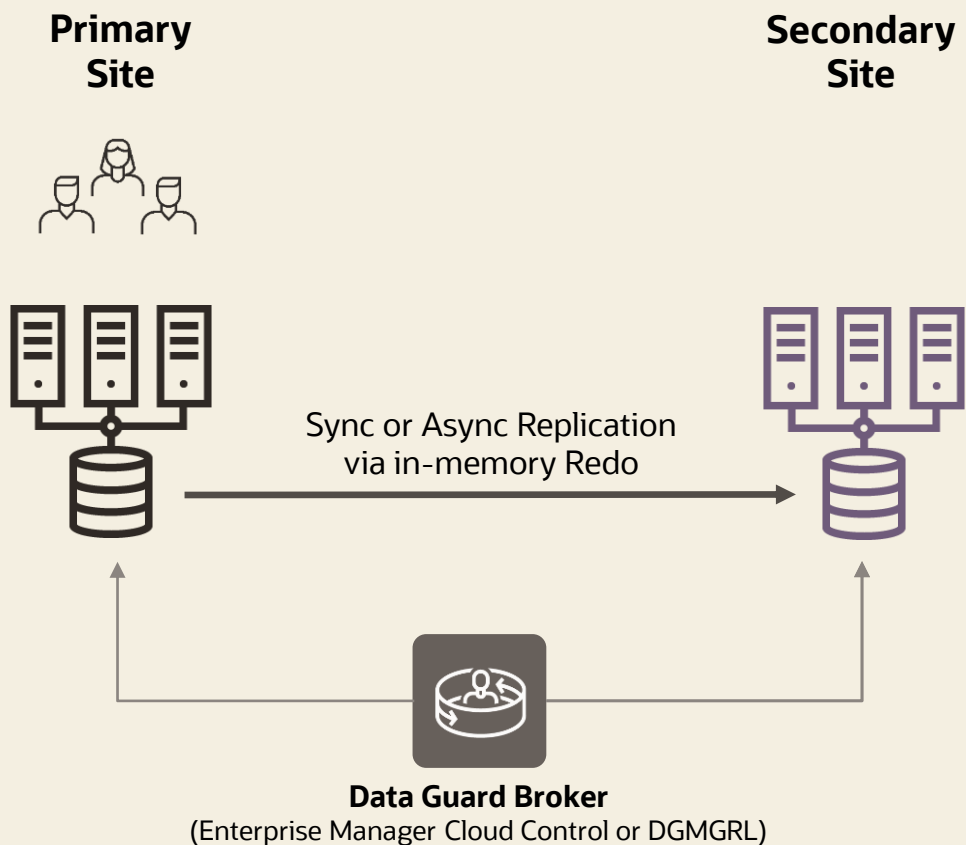

- **Basic in-memory redo replication (included with DB EE)**
  - License primary and secondary sites
- **Active-passive**
  - Standby is used only for failovers
- **Automatic failover to Standby site**
- **Zero / near-zero data loss**
- **Continuous data validation**
- **Simple migrations and upgrades**



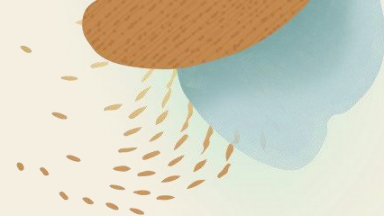

# Data Guard is Optimized for the Database

## Better than storage mirroring or 3<sup>rd</sup> party solutions

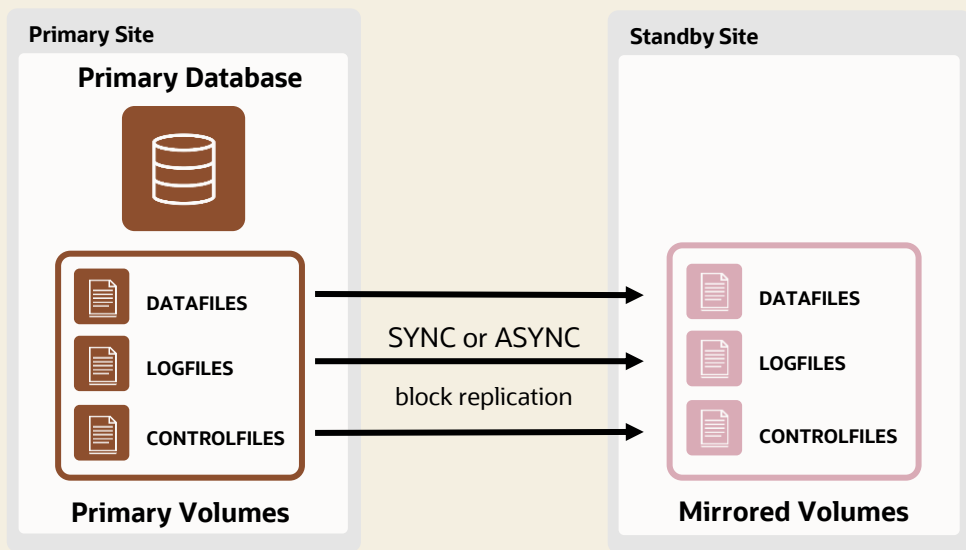

### Traditional replication

- Corruptions are replicated
- Unusable destination
- 7x network volume
- 27x network I/O
- Standby needs warm-up

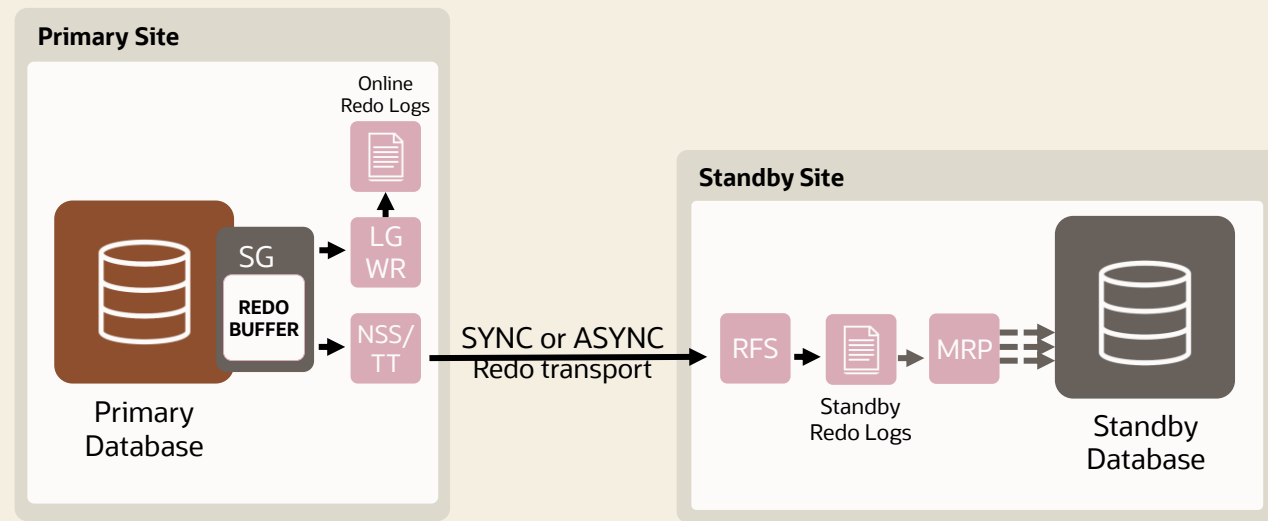

### Data Guard replication

- **Validation end to end**
- **Ransomware Protection**
- Only the essential information is replicated
- Efficient and performant
- **Implicit Integrity**



# Data Guard per Pluggable Database

- Two Container Databases (CDB) actively running workload
  - Both open read-write with different database IDs
- Disaster Protection at the PDB level
  - No need to fail over a full Container Database
  - Role transition on a single PDB with Data Guard Broker
  - Automatic gap fetching from the source
  - ASYNC support
- Real-Time Query for DGPDB configurations now available in Oracle AI Database 26ai

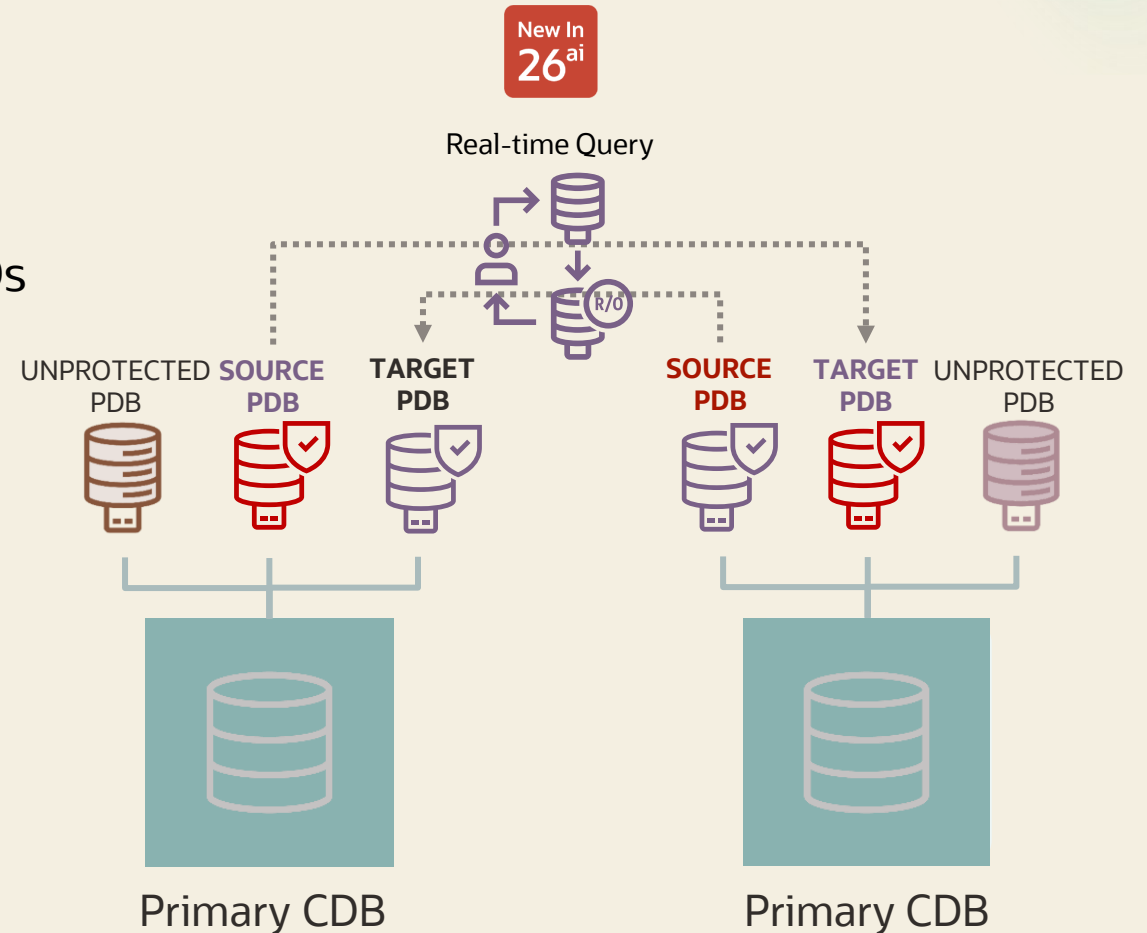



# Global scale with Globally Distributed Database

Horizontal partitioning of data across independent databases (shards)

- Each shard holds a subset of the data
- Replicated for high availability

## Shared-nothing architecture

- Shards don't share any hardware (CPU, memory, disk), or software (Clusterware)

## Massively Parallel Processing

- Application connects directly to a shard
- Multi-Shard queries go through the coordinator

## Ideal for data sovereignty

- User-defined data placement for complying with regulatory requirements
- New in Oracle AI Database 26ai:
  - RAFT replication option for Globally Distributed Database

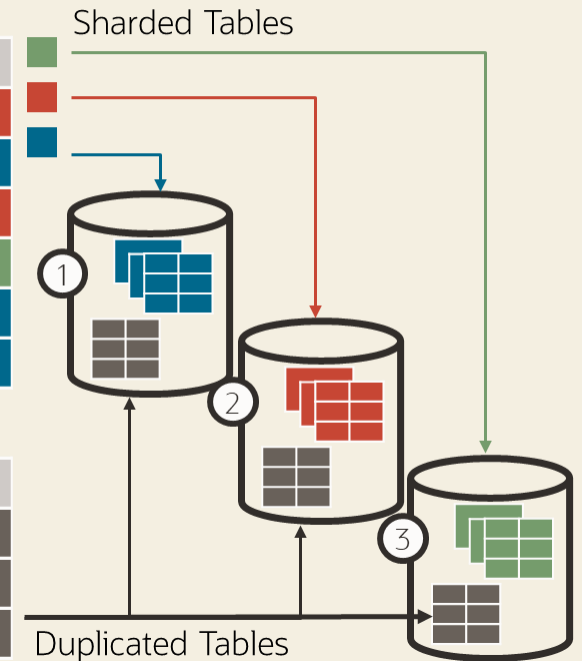
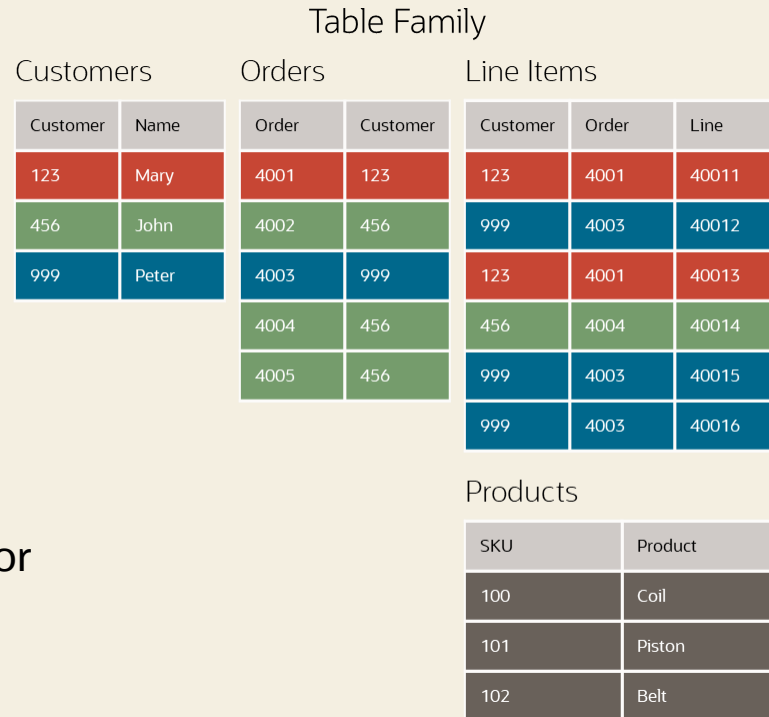



# Active-active Globally Distributed Database

## Raft Replication

- Built-in replication, integrated with transaction execution
- Fast and automatic sub-3-second failover with zero data loss
- Active-active, symmetric configuration
  - Each shard accepts writes and reads for a subset of data
- Easy: no need to configure Data Guard or GoldenGate for shards

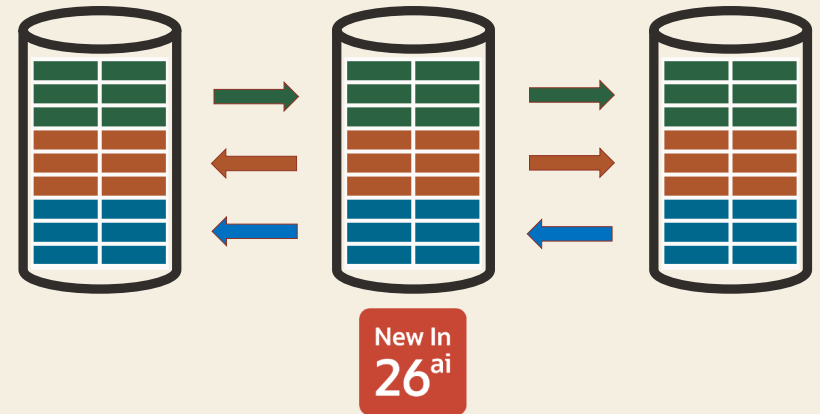

- Globally Distributed Database is divided into multiple replication units
  - Replication unit replicas are spread evenly across 3 (or more) shards
  - Each shard is both a primary (leader) for some replication units and a follower (replica) for other replication units

- Builds on popular Raft distributed consensus protocol
  - Guarantees consistency among replicas in case of failures, network partition, message loss, or delay
  - Automatic reconfiguration after failure, or when the number of shards changes

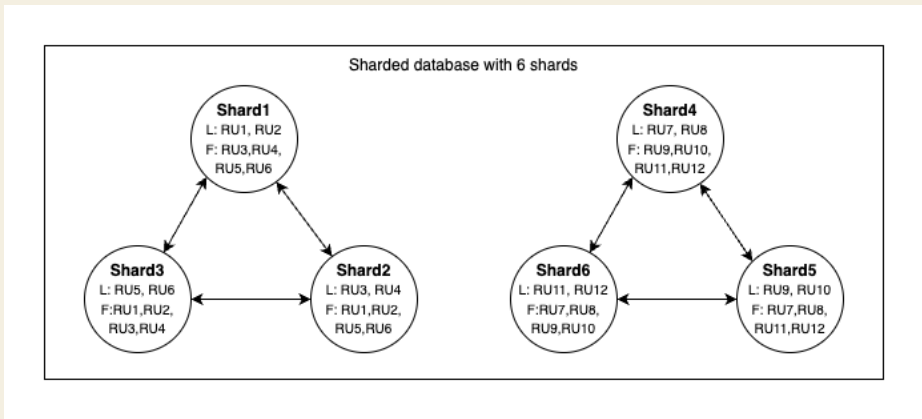



# GOLD

## Business Critical

### Silver (Option 1 with RAC) +

- Active Data Guard
- Comprehensive Data Protection

### MAA Architecture:

- At least one standby is required across AD or region.
- Primary in one data center(or AD) replicated to a Standby in another data center
- Data Guard Fast-Start Failover (FSFO)
- Local backups on both primary and standby

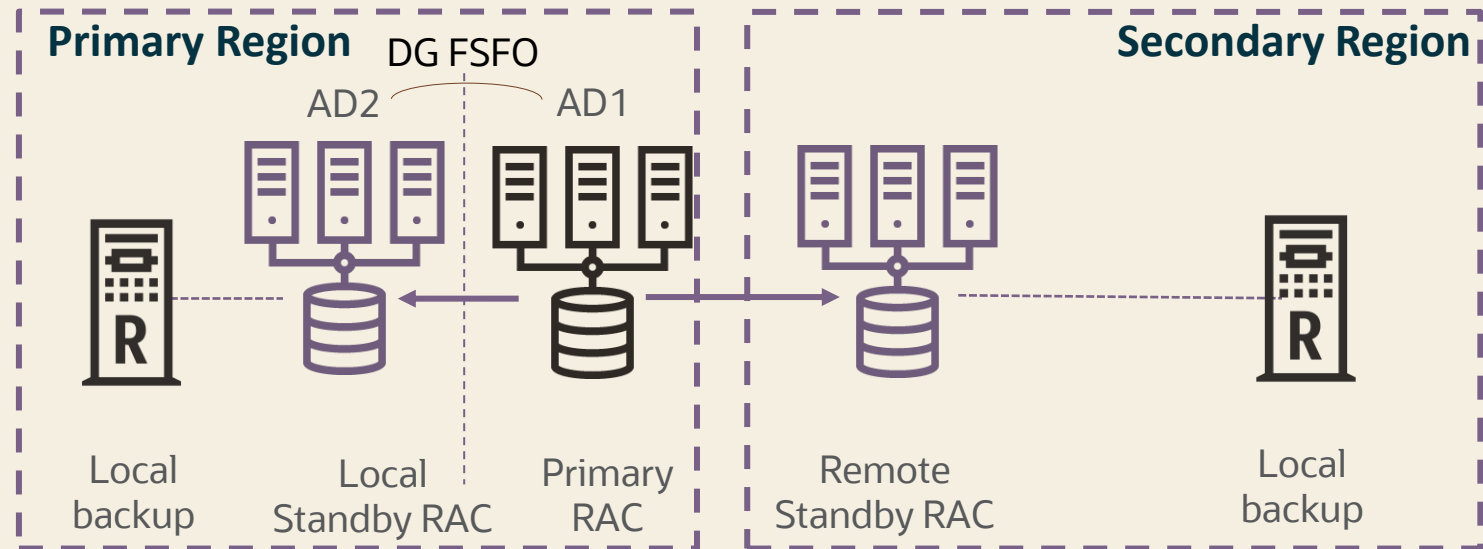

## Outage Matrix

Unplanned Outage	RTO/RPO Service Level Objectives (f1)
Recoverable node or instance failure	< 30 seconds (f2)
Disasters: corruptions and site failures	<b>Seconds to 2 minutes. RPO zero or seconds</b>
Planned Maintenance	
Software/Hardware updates	Zero (f2)
Major database upgrade	<b>&lt; 30 seconds</b>

f1: RPO=0 unless explicitly specified

f2: To achieve zero downtime or lowest impact, apply application checklist best practices; Batch jobs should be deferred outside planned maintenance window.





# Oracle Data Protection

## Gold – Comprehensive Data Protection

	Capability	Physical Block Corruption	Logical Block Corruption
Manual	Dbverify, Analyze	Physical block checks	Logical checks for intra-block and inter-object consistency
	RMAN, ASM	Physical block checks	Intra-block logical checks
Runtime	Active Data Guard	<ul style="list-style-type: none"> <li>• Continuous physical block checking at standby</li> <li>• Strong isolation to prevent single point of failure</li> <li>• Automatic repair of physical corruptions</li> <li>• Automatic database failover (option for lost writes)</li> </ul>	<ul style="list-style-type: none"> <li>• <b>Detect lost write corruption, auto shutdown and failover</b></li> <li>• <b>Intra-block logical checks at standby</b></li> </ul>
	Database	In-memory block and redo checksum	In-memory intra-block checks, shadow lost write protection
	ASM	Automatic corruption detection and repair using extent pairs	
	Exadata	HARD checks on write, automatic disk scrub and repair	HARD checks on write



# Oracle Active Data Guard

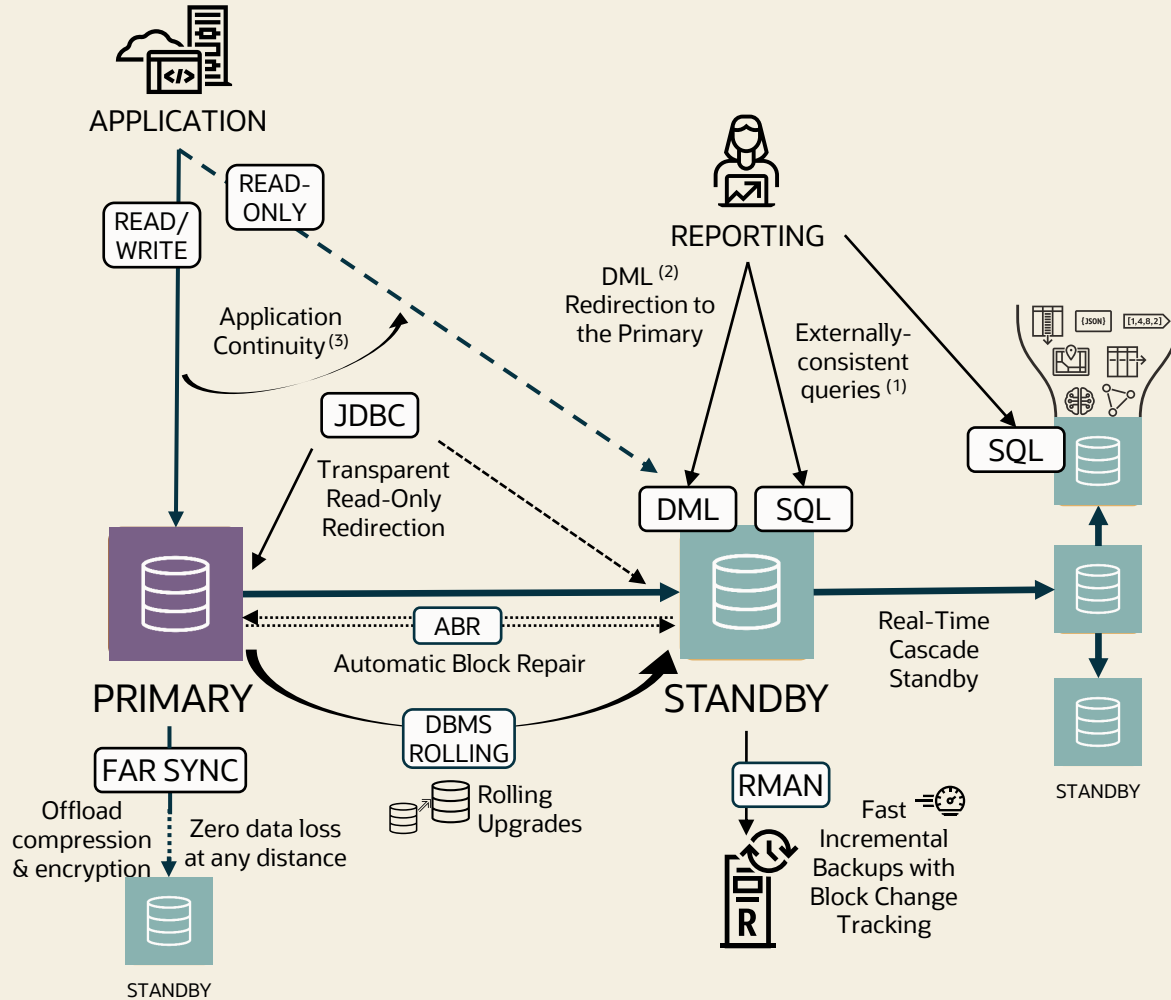
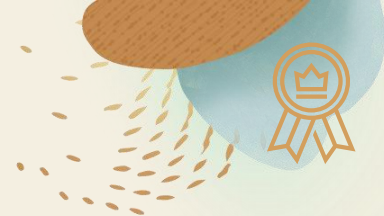

## Offload & scale

Don't leave your standby infrastructure idle:

- **Offload** queries, reports, and backups
- **Linearly scale** the application's read-only activity
- **Increase** read/write **throughput** by freeing important resources
- Transparently load balance across replicas

## Enhanced protection

- All your transactions are **protected regardless of the distance**
- Block corruptions are **fixed** on the fly **without application errors**
- Cascaded standbys protect your transactions without delay
- Backups are **incredibly fast**, also on the standby database

## Higher availability

- Major **upgrades are transparent** or require minimal downtime
- **Mask failovers** to the application **without additional coding**



# Offload Inferencing and AI Vector Search to Oracle Active Data Guard

Leverage the standby for AI workloads, keeping the primary free for mission-critical transactions

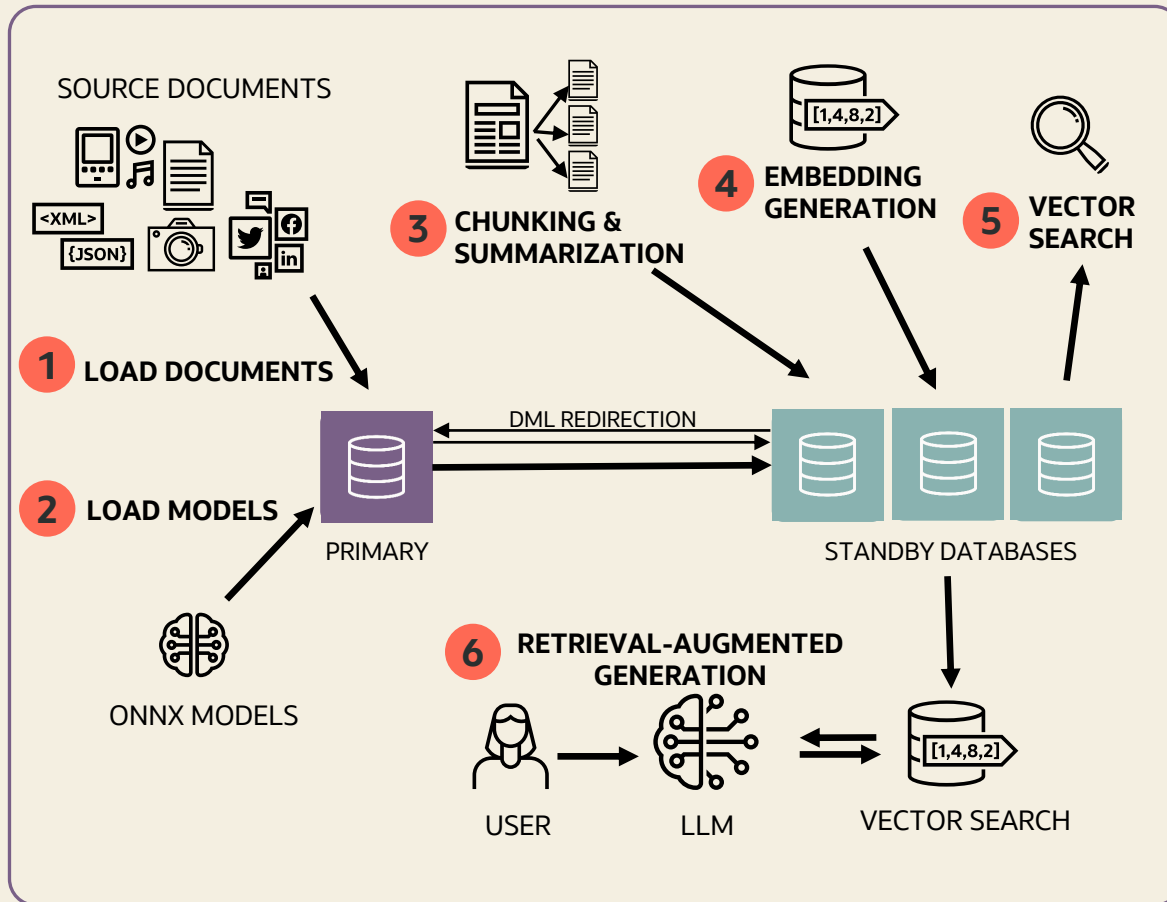

- Offload CPU-intensive workloads
  - Inferencing
  - Chunking and summarization
  - AI Vector Search
- Embeddings are created on the standby database
- Vectors are inserted via DML Redirection
- Standby resources are fully utilized

**Primary database performance is unaffected**



<https://blogs.oracle.com/maa/onnx-on-active-data-guard>

# Active Data Guard Far Sync

## Zero Data Loss Protection at Any Distance

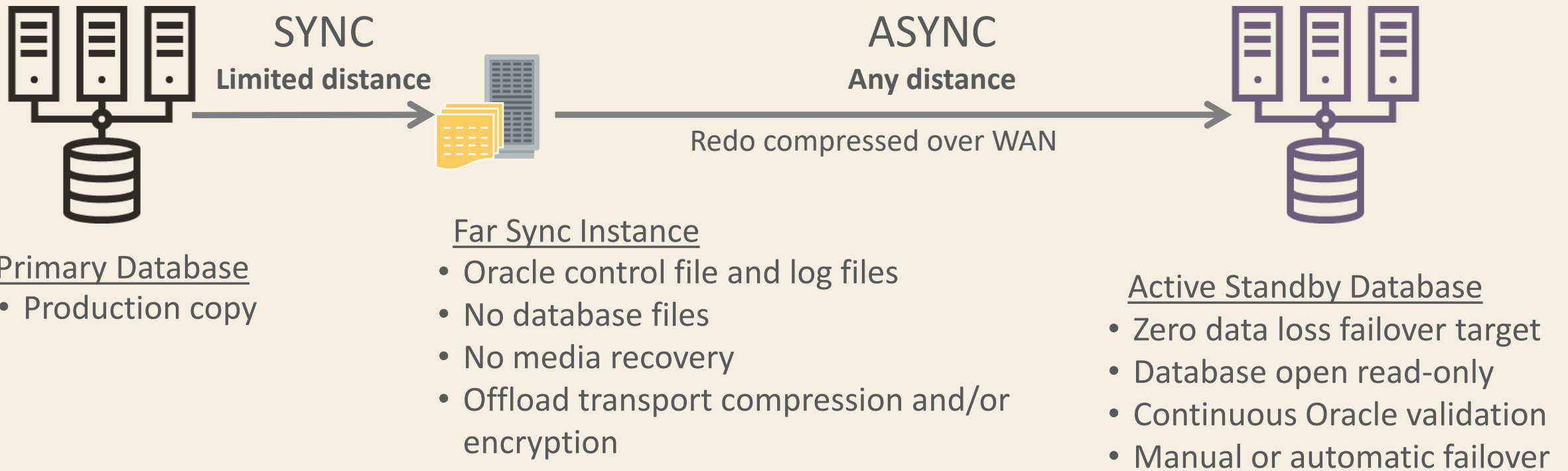
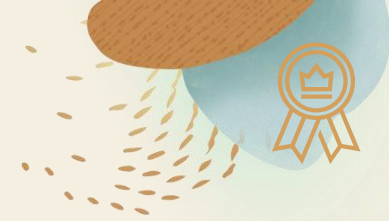

# Unplanned Outages, Application Continuity expanded to the Standby

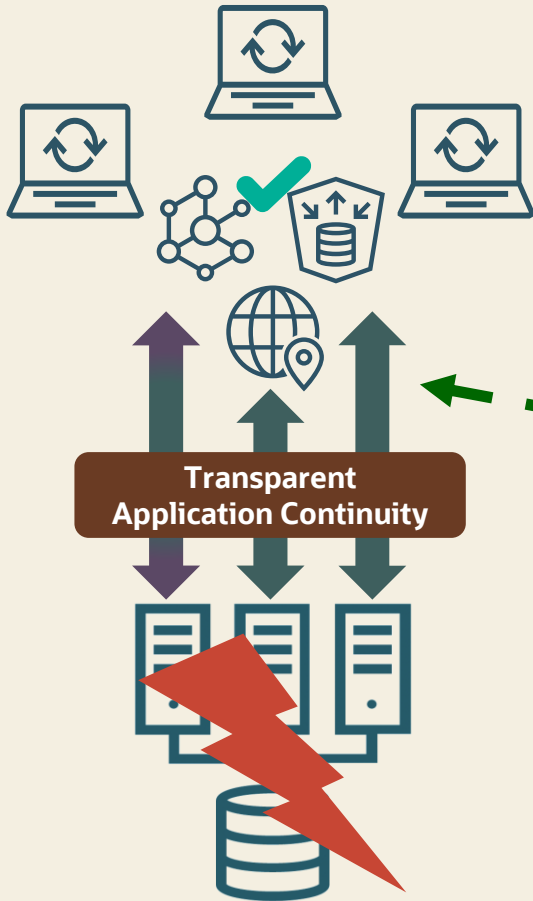
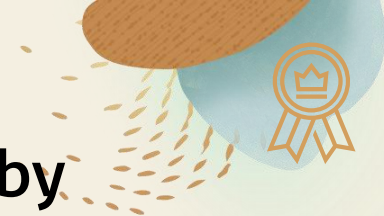

Primary RAC Database

## Outage or Interruption at Database:

- Database Request interrupted by an Outage or timeout
- Session reconnects to the RAC Cluster (or Standby) and
- Database Request replays automatically
- Result from Database Request returned to the user
- Oracle AI Database 26ai provides Application Continuity through DBMS\_ROLLING operations.



Active Data Guard Standby



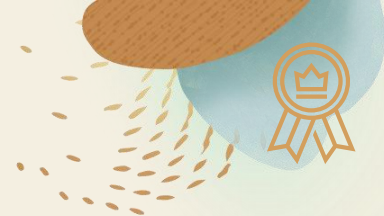

# Active Data Guard Rolling Maintenance and Upgrades

Using DBMS\_ROLLING package

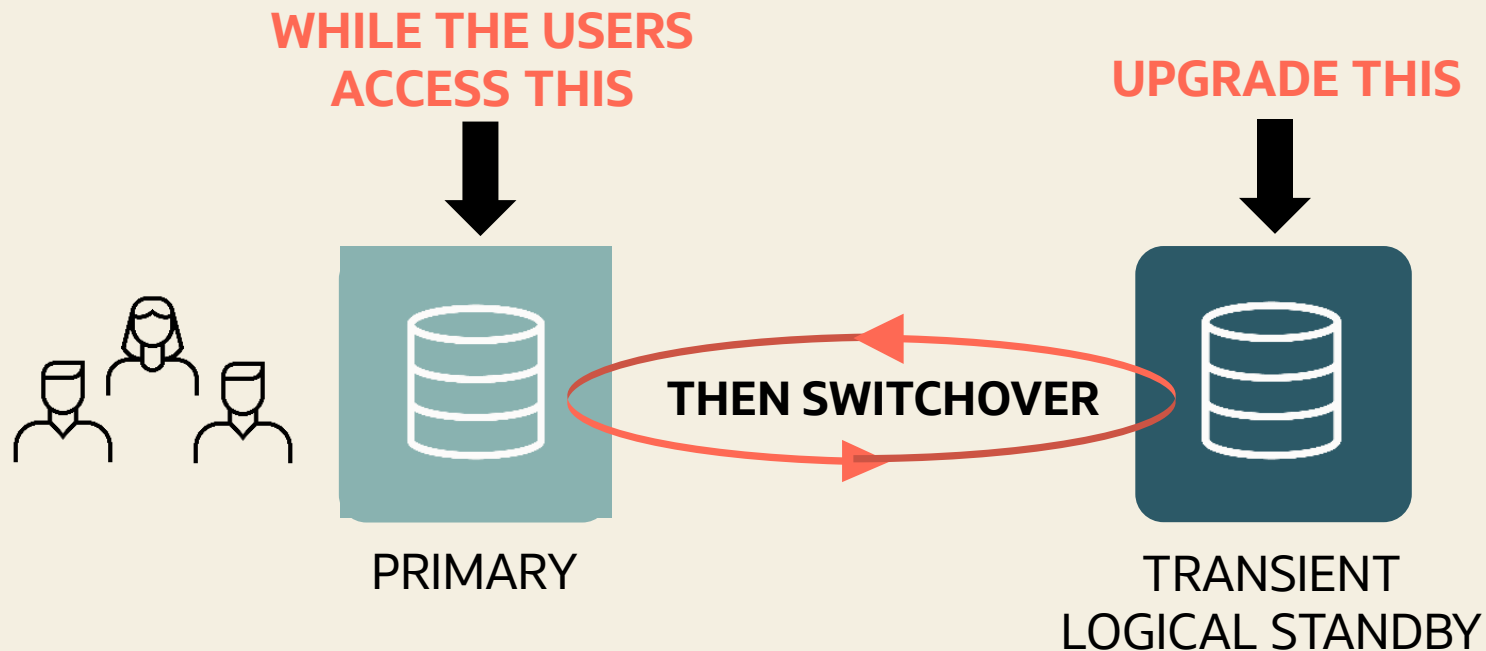

- Use a transient logical standby database to upgrade with very little downtime.
- The only downtime is as little as it takes to perform a switchover.
- Oracle AI Database 26ai provides Application Continuity Support



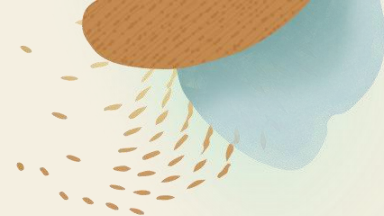

# Different Ways to Configure Oracle Data Guard

For easy integration with DevOps and configuration pipelines

dgmgrl

```
DGMGR> create configuration mydb
> as primary database is mydb
> connect identifier is 'clu-scan:1521/mydb'
```



```
SQL> DG create configuration mydb as primary database is
mydb connect identifier is 'clu-scan:1521/mydb'
```

PL/  
SQL

```
DECLARE
  severity BINARY_INTEGER;
  retcode  BINARY_INTEGER;
BEGIN
  retcode := DBMS_DG.CREATE_CONFIGURATION (
    config_name      => 'mydb'
    primary_ci       => 'clu-scan:1521/mydb'
    severity         => severity
  );
END;
```



```
POST /database/dataguard/configuration/
{
  "primary_connection_identifier": "clu-scan:1521/mydb",
  "primary_database": "mydb_site1"
}
```





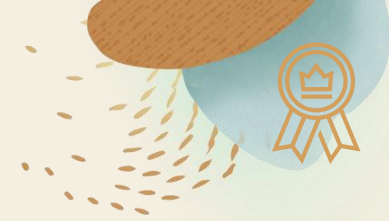

# Extend Footprint of Active Data Guard Applications

## Support for DML Re-direction

- DML Re-direction is automatically performed from an Active Data Guard standby to the primary (**ACID uncompromised**)
- New parameter `ADG_REDIRECT_DML` controls DML Redirection
- New `ADG_REDIRECT_DML` and `ADG_REDIRECT_PLSQL`
- “Read-Mostly, **Occasional Updates**” applications supported for Oracle AI Database 19c and above

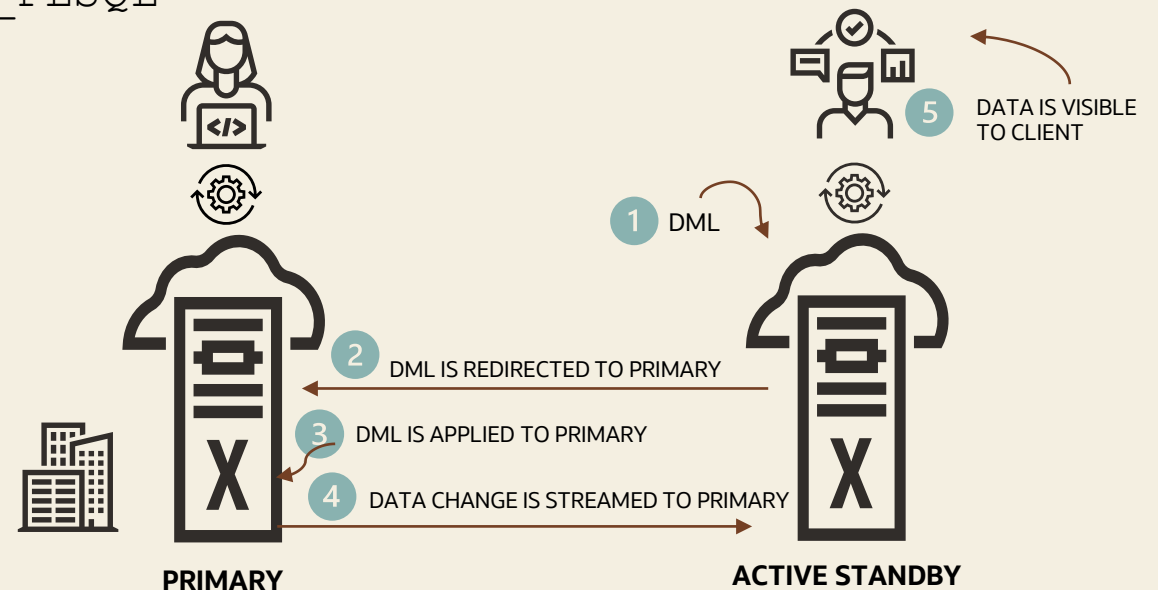



# Tunable Automatic Outage Resolution

Data Guard maintains internal mechanisms that detect and correct issues with its redo transport and gap resolution processes

- In case of network or disk I/O problems, these mechanisms prevent those processes from hanging and causing unnecessarily *long gaps (or is it hangs?)*

Use the following parameters to influence the outage resolution:

- **DATA\_GUARD\_MAX\_IO\_TIME**
  - Sets the maximum number of seconds that can elapse before a process is considered hung while performing reads, writes, and status operations.
- **DATA\_GUARD\_MAX\_LONGIO\_TIME**
  - Sets the maximum number of seconds as above, but for operations such as open and close



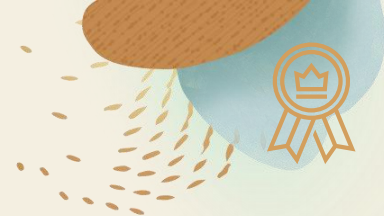

# Standby Result Cache Preservation

Keep the Result Cache warm after a role transition

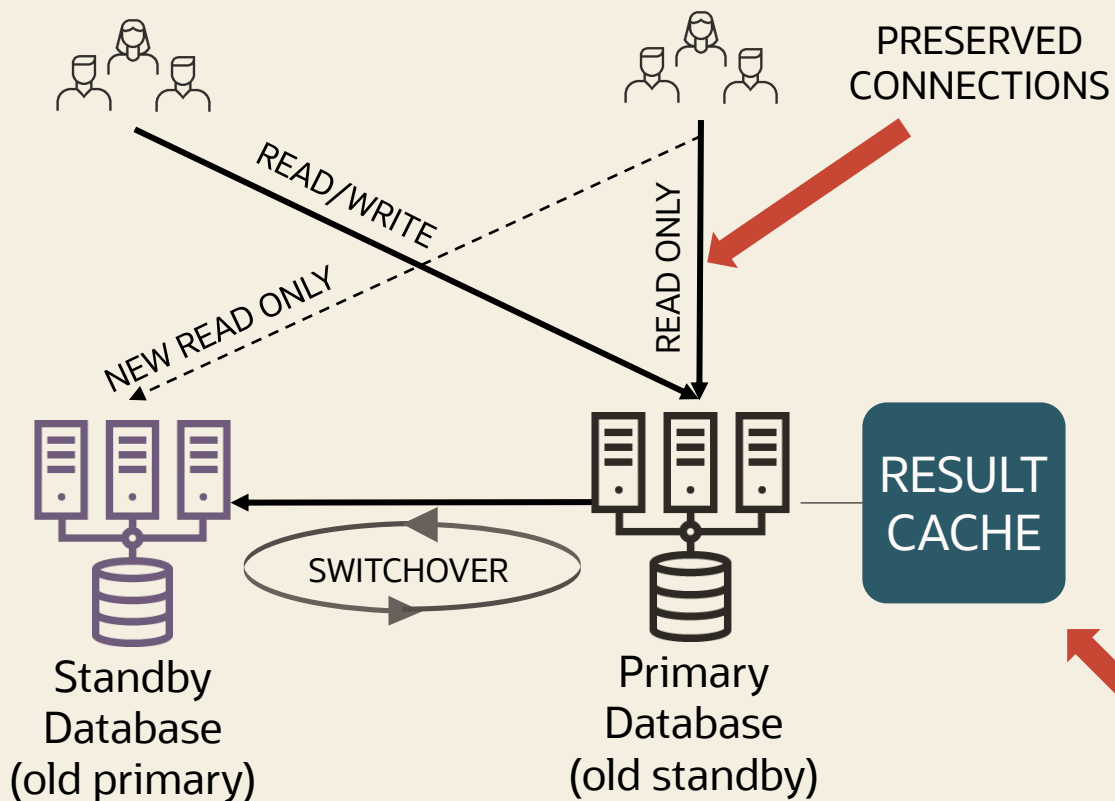

- Real-Time Query supports the Result Cache for queries run on the standby database (tables only)
- Result Cache improves query performance for recurring queries and reduces resource usage (CPU, I/O)
- In **21c and above**, after a role transition (switchover or failover), the Result Cache is preserved
  - Query performance not impacted
  - No cache warm-up required



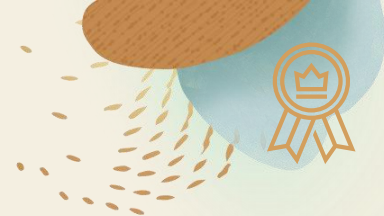

# Multi-Instance Redo Apply Performance

## Lower Latency Active Data Guard Standby Databases

- Utilizes all RAC nodes on the Standby database to parallelize recovery
- OLTP workloads on Exadata show great scalability

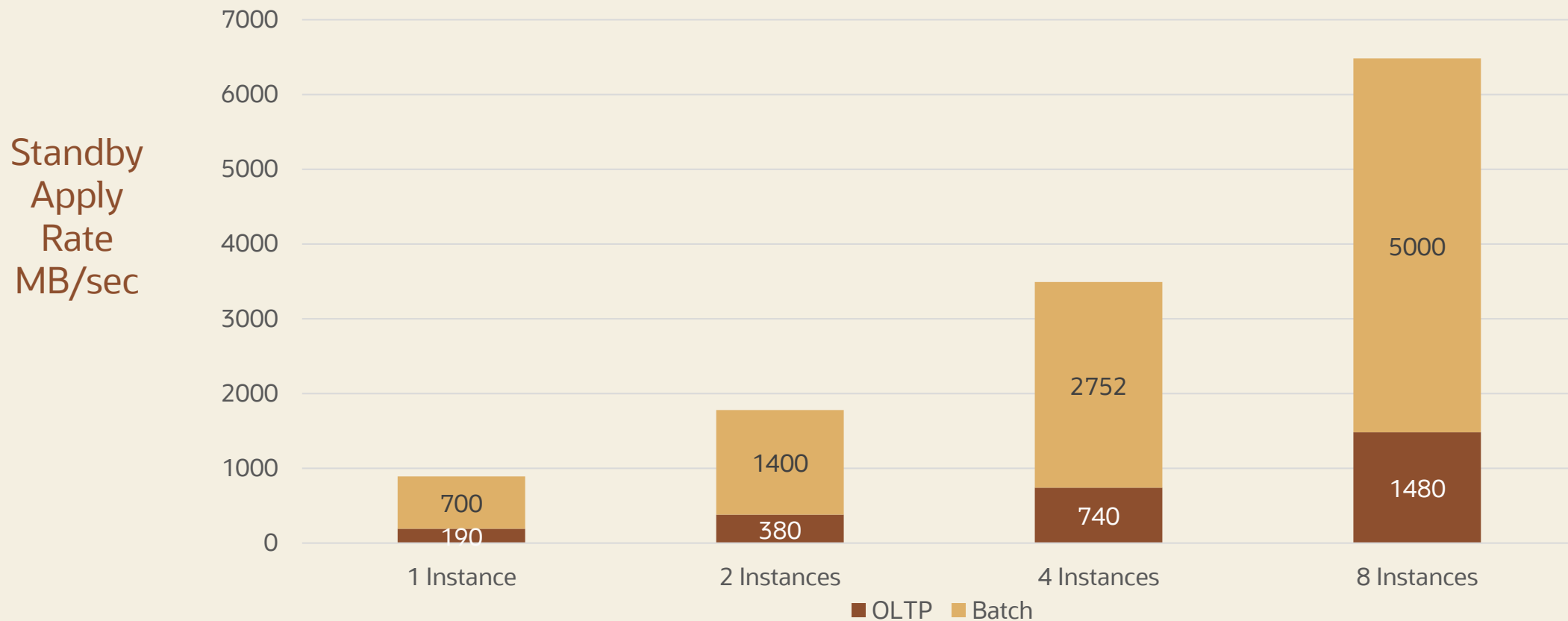

# PLATINUM

## Mission Critical (Option 1)

### Gold +

- GoldenGate Active/Active Replication
- Exadata
- Edition-based Redefinition (Alternative)

### MAA Architecture:

- Each GoldenGate “primary” replica protected by Exadata, RAC and Active Data Guard
- Primary in one data center (or AD) replicated to another Primary in remote data center (or AD)
- Oracle GG & Edition-based Redefinition for zero downtime application upgrade
- Achieve zero downtime through custom failover to GG replica

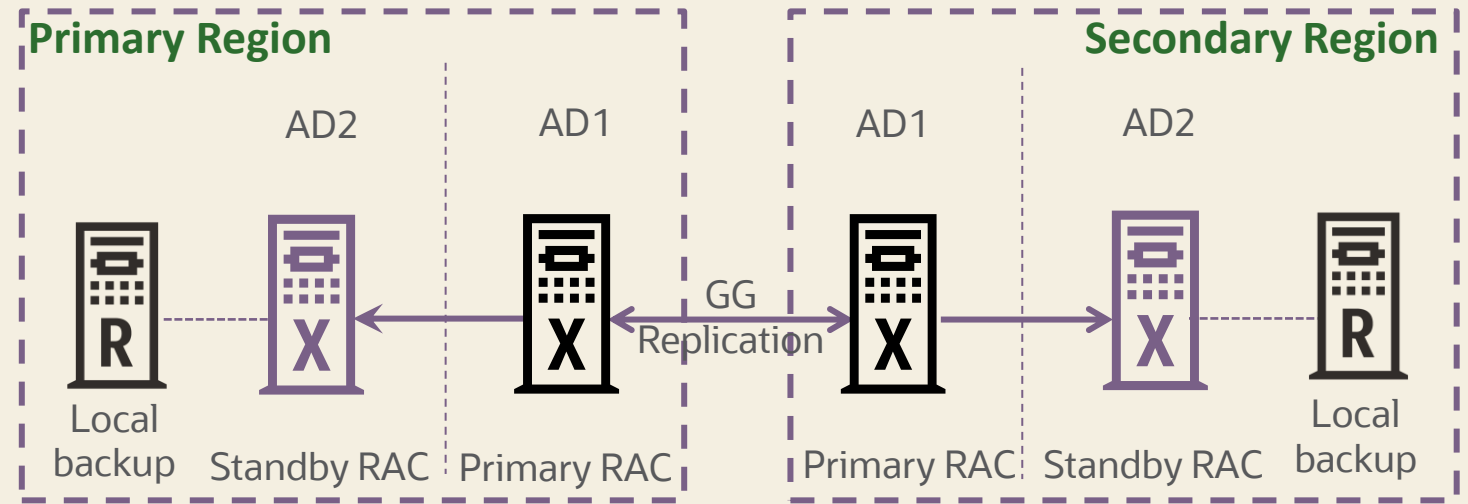

## Outage Matrix

Unplanned Outage	RTO/RPO Service Level Objectives (f1)
Recoverable node or instance failure	<b>Zero or single-digit seconds (f2/f3)</b>
Disasters including corruptions and site failures	<b>&lt; 30 secs (f3)</b>
Planned Maintenance	
Most common software/hardware updates	Zero (f2)
Major database upgrade, <b>application upgrade</b>	<b>Zero (f3)</b>

f1: RPO=0 unless explicitly specified

f2: To achieve zero downtime or lowest impact, apply application checklist best practices

f3: Application failover is custom or with Global Data Services



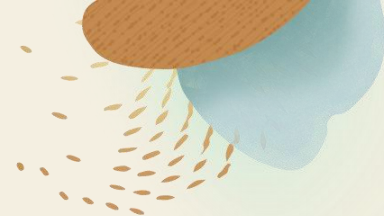

# Exadata Maximum Availability Architecture (MAA)

Optimized on-premises blueprint for HA: designed/tested against failure scenarios

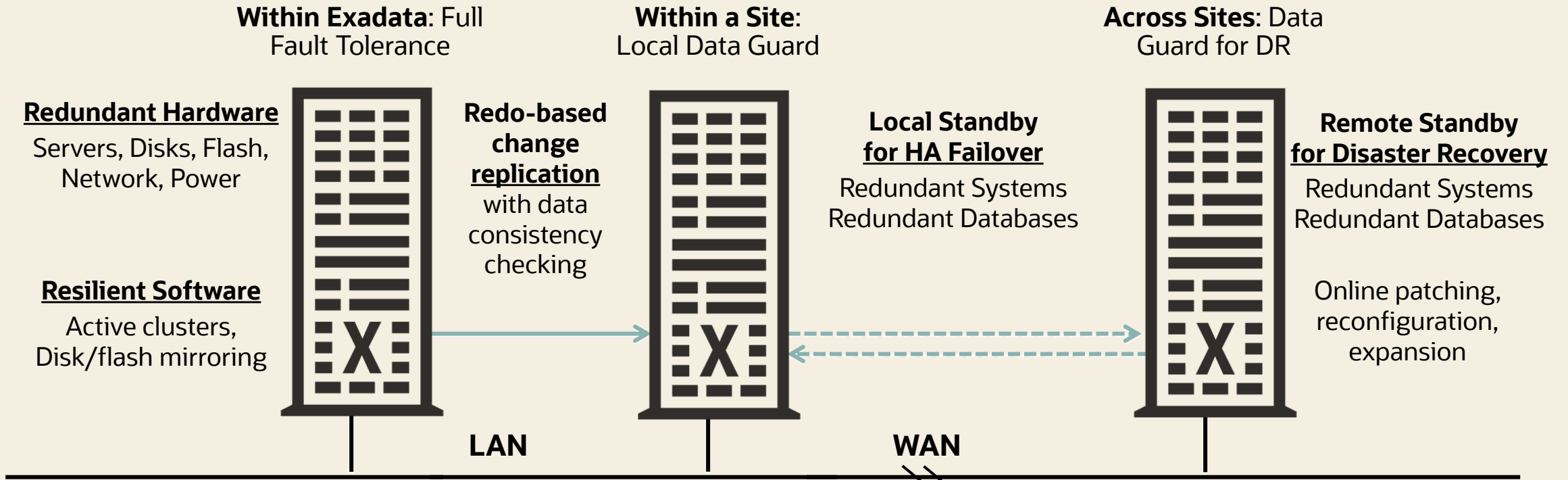

**Fastest RAC recovery after node or instance failure | Fastest Backup - RMAN Offloads to Storage  
Seamless ASM Integration | Fastest Data Guard Redo Apply | Automated Chaos Engineering injection testing**



# GoldenGate or Alternatively Edition-based Redefinition to Further Protect Your Applications



Use Oracle Golden Gate  
Standard Approach

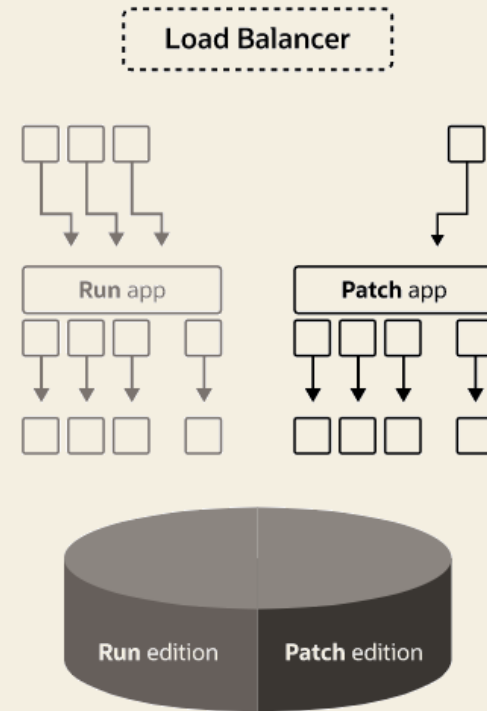

Use Edition-based Redefinition  
Alternative



# GoldenGate or Alternatively Edition-based Redefinition to Further Protect Your Applications



Use Oracle Golden Gate  
Standard Approach

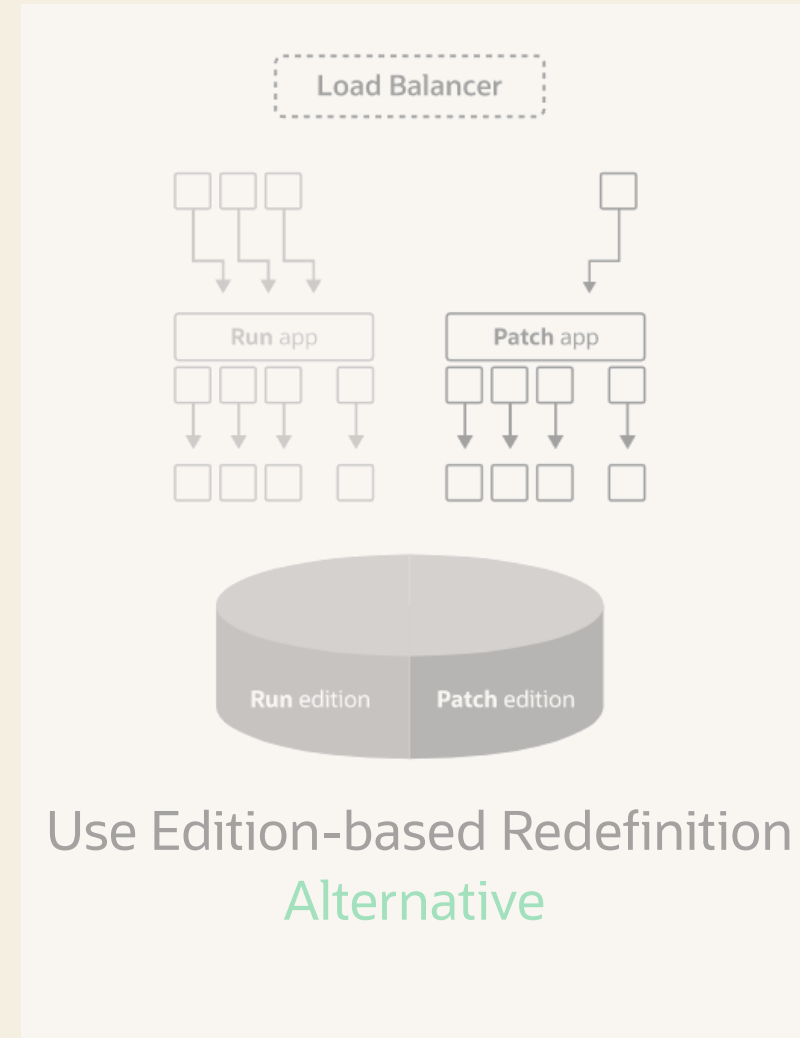

Use Edition-based Redefinition  
Alternative







# Oracle GoldenGate Architecture

Multiple primaries ensure maximum availability even during maintenance periods

- Eliminates downtime with Bi-directional full active-active replication between regions
- Asynchronous logical replication provides flexibility for maintenance activities
- Different hardware supported
- Regional affinity supports geographical distribution
- Combine with synchronous local standby databases or remote standby databases using Active Data Guard to eliminate data loss

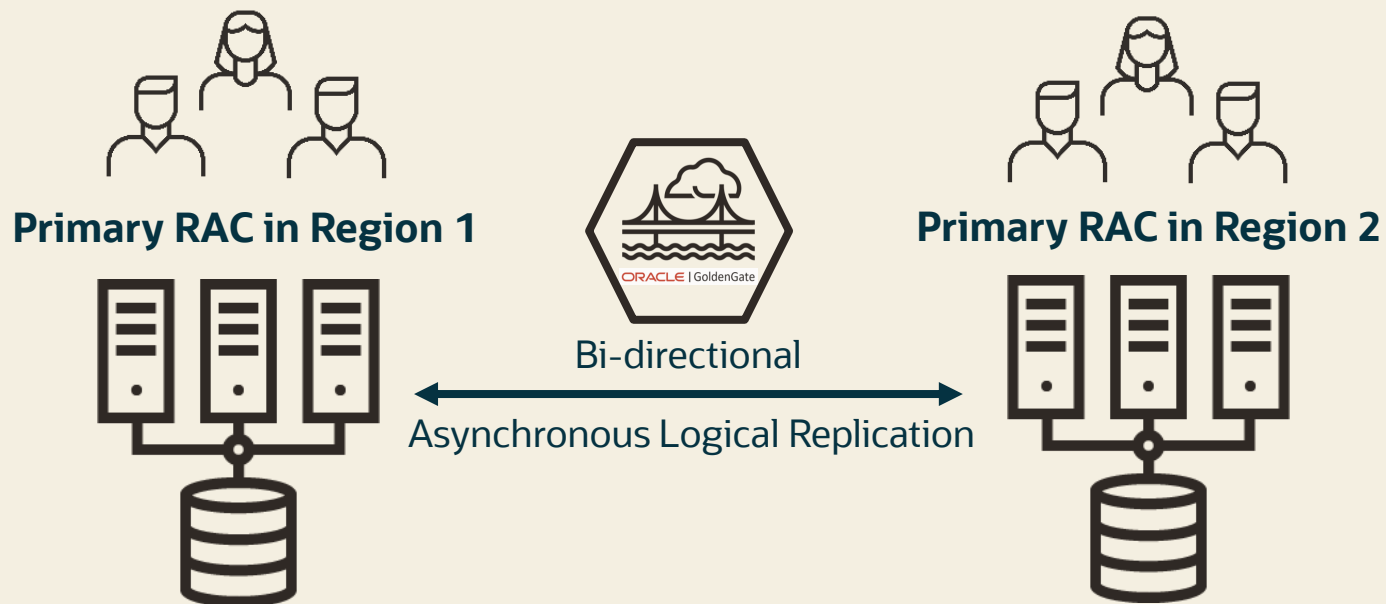

# Oracle GoldenGate Architecture



**Capture:** committed transactions are captured (and can be filtered) as they occur by reading the transaction logs.

**Trail:** stages and queues data for routing.

**Distribution Server/Receiver:** distributes data for routing to target(s).

**Route:** data is compressed, encrypted for routing to target(s).

**Delivery:** applies data with transaction integrity.

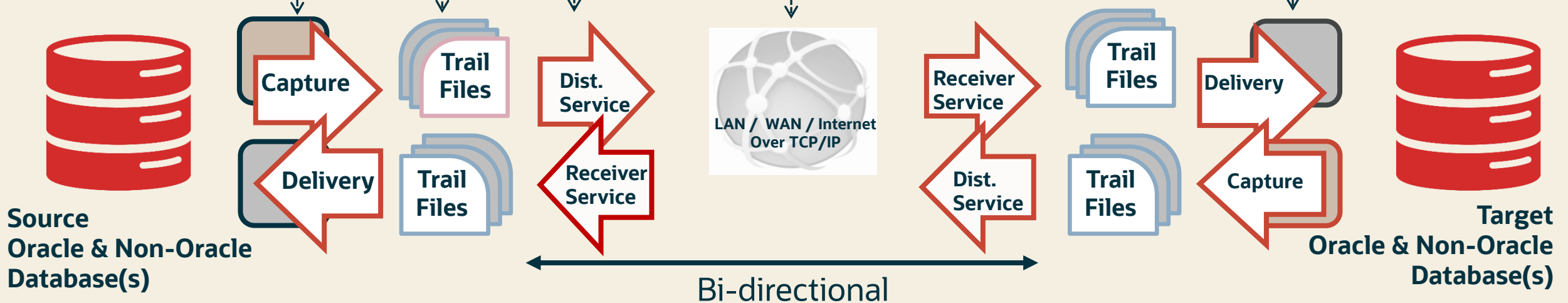



# Key GoldenGate Improvements Simplify Platinum

1. GoldenGate Hub simplifies migration and administration by offloading work from source and target
  - New GoldenGate cloud marketplace automates GG hub deployment
  - Cross endianness capture enables cross platform migration
  - Zero Downtime Migration integration with GoldenGate
2. GoldenGate Microservices simplifies administration and management

Zero Downtime Migration  
[www.oracle.com/goto/zdm](http://www.oracle.com/goto/zdm)

[Resource Link: Oracle Database Migration with an Oracle GoldenGate Hub Configuration](#)

[Resource Link: Oracle Maximum Availability Architecture \(MAA\) GoldenGate Hub](#)





# Oracle GoldenGate

## MAA Best Practices

- Transparent Role Transitions in Data Guard Configurations
  - No manual intervention required with FSFO and DG Broker
- Configuration makes use of:
  - Oracle Grid Infrastructure Bundled Agent (XAG)
  - DBFS or ACFS for shared GoldenGate files (trails and checkpoint files)
  - Role based services
  - Integrated Extract (with HANDLEDLFAILOVER option for ASYNC DG)
  - Microservices Architecture for simpler administration

[Resource Link: Transparent Role Transitions with Data Guard and Oracle GoldenGate](#)





# Sample GoldenGate MAA Deployment

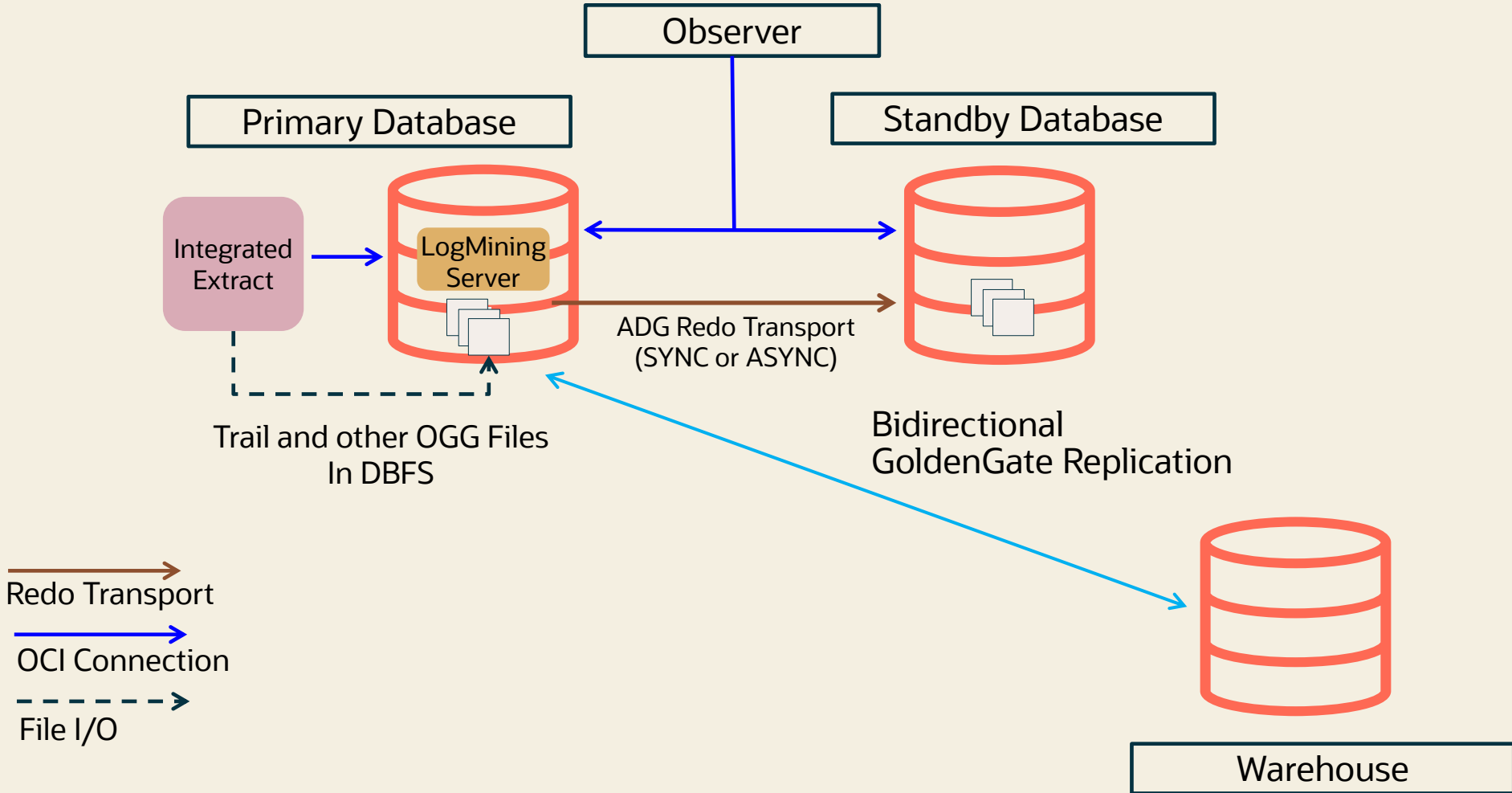



# Sample GoldenGate MAA Deployment – Post Role Transition

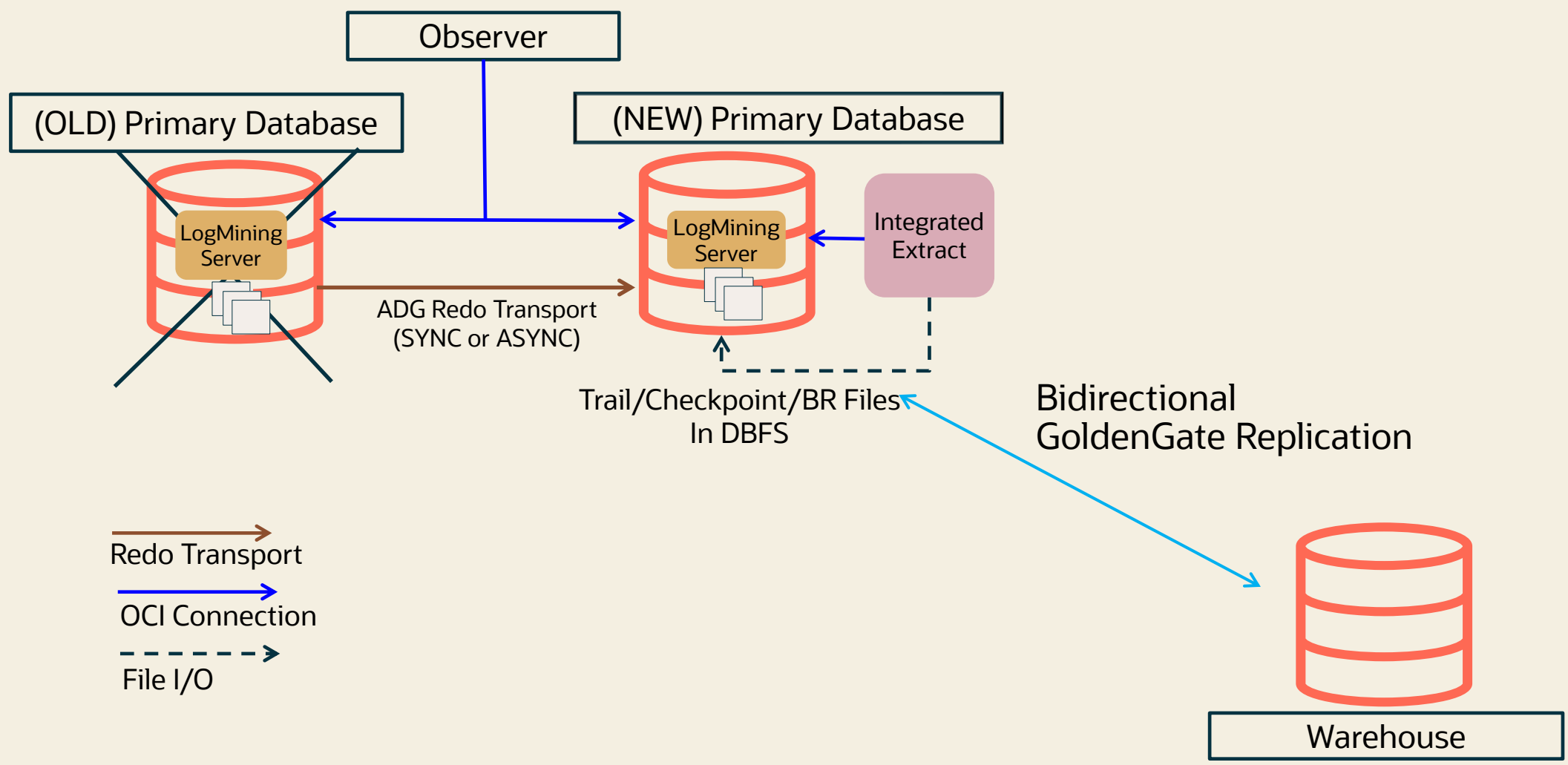

# GoldenGate or Alternatively Edition-based Redefinition to Further Protect Your Applications



Use Oracle Golden Gate  
Standard Approach

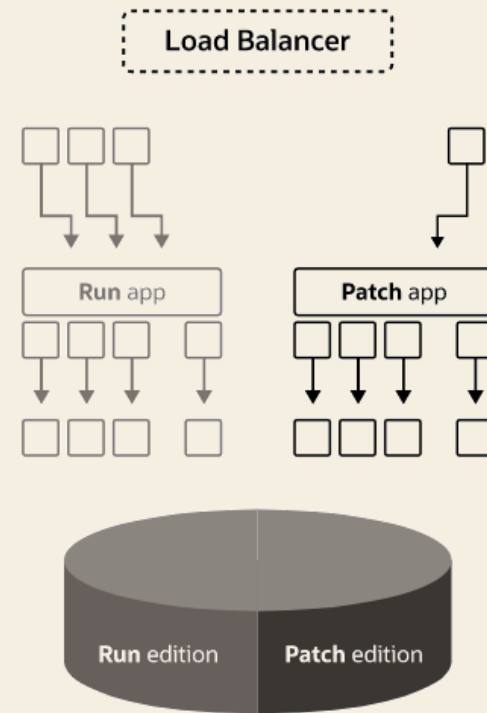

Use Edition-based Redefinition  
Alternative

# Edition-Based Redefinition

## Online Application Upgrade

- Enables application upgrades to be performed online
- Code changes installed in the privacy of a new **edition**
- Data changes are made safely by writing only to new columns or new tables not seen in the old edition
- An **editioning view** exposes a different projection of a table into each edition to allow each to see just its own columns
- A **cross-edition trigger** propagates data changes made by the old edition into the new edition's columns, or (in hot-rollover) vice-versa
- With Oracle AI Database 26ai, EBR is now compatible with Oracle GoldenGate thanks to supplemental logging enhancements

New In  
26<sup>ai</sup>

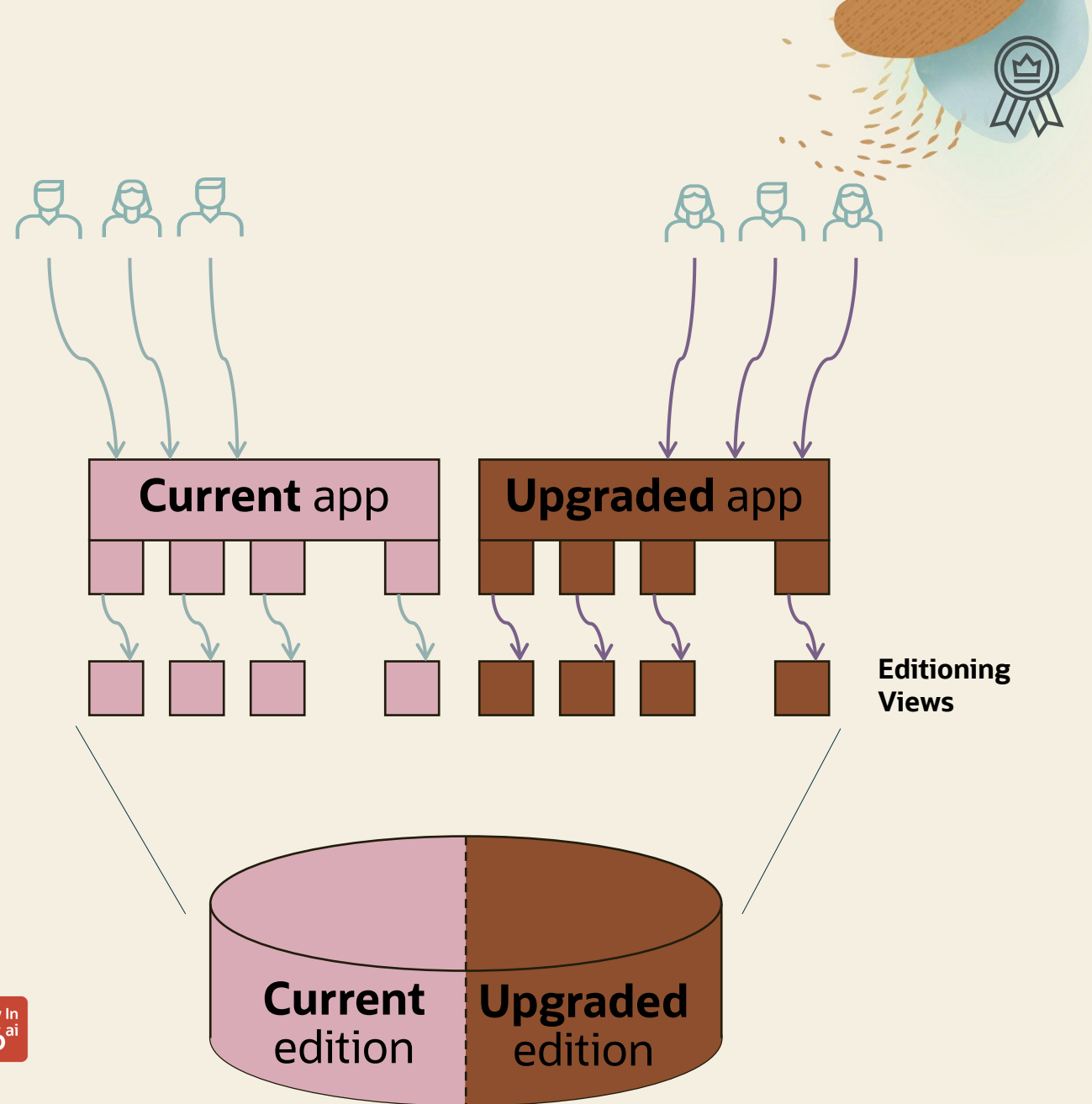



# PLATINUM

## Mission Critical (Option 2)

### Gold +

- Oracle AI Database 26ai
- Exadata
- Active Data Guard
  - Comprehensive Data Protection

### MAA Architecture:

- At least one standby is required across AD or region.
- Primary in one data center(or AD) replicated to a Standby in another data center
- Data Guard Fast-Start Failover (FSFO)
- Local backups on both primary and standby

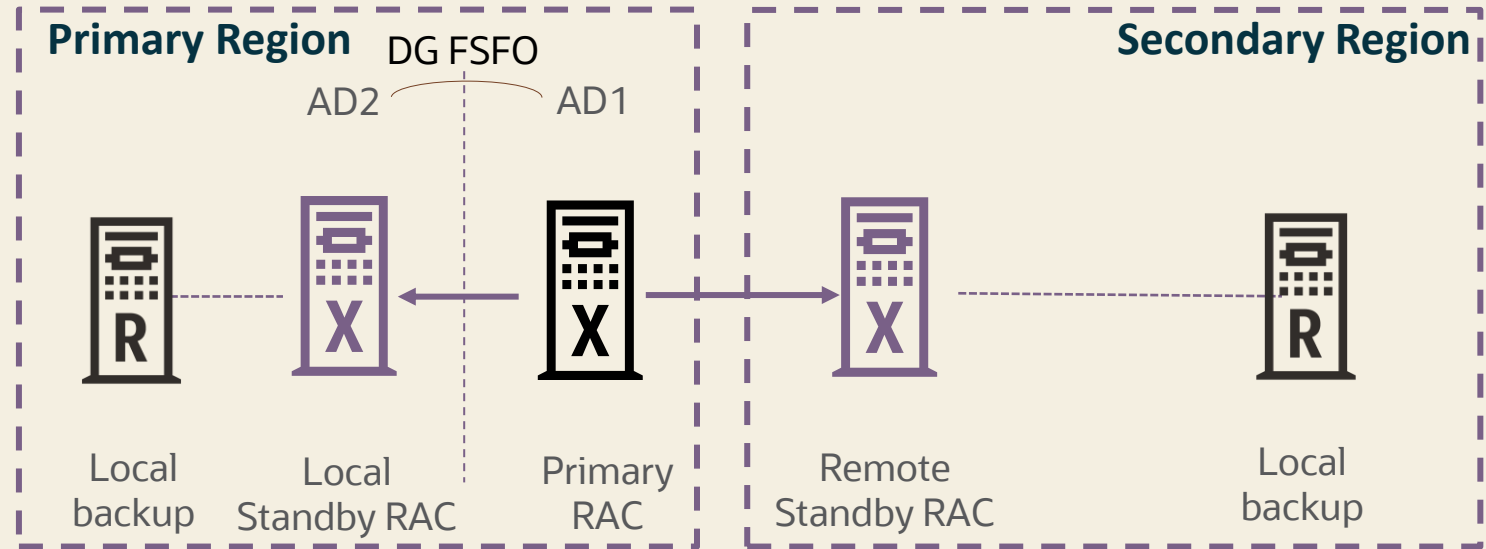

## Outage Matrix

Unplanned Outage	RTO/RPO Service Level Objectives (f1)
Recoverable node or instance failure	Single digit seconds (f2)
Disasters: corruptions and site failures	<b>Seconds to 1 min. RPO zero or seconds</b>
Planned Maintenance	
Software/Hardware updates	Zero (f2)
Major database upgrade	<b>Less than 30 seconds</b>

f1: RPO=0 unless explicitly specified

f2: To achieve zero downtime or lowest impact, apply application checklist best practices; Batch jobs should be deferred outside planned maintenance window.



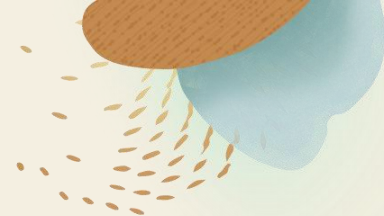

# Oracle Data Guard 26ai Provides Lower RTO

Faster role transitions regardless of the size of the workload

## SMALL WORKLOAD

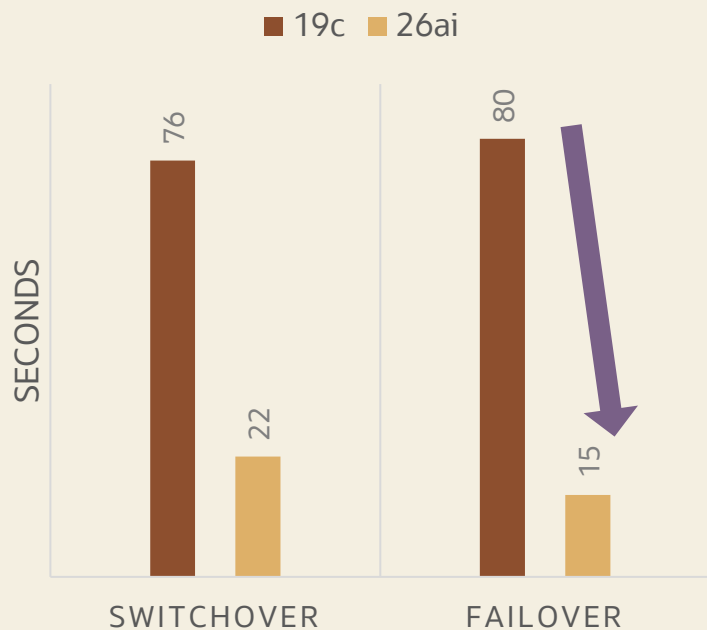

UP TO  
**400%**  
FASTER

## LARGE WORKLOAD

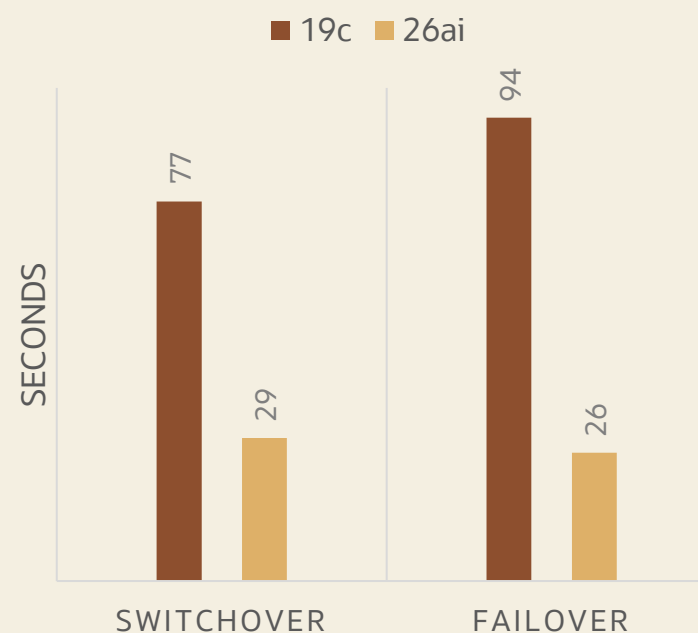

Workload	System	PDBs	Data Files	Services	Redo Rate
SMALL	2-node Exadata RAC	5	50	10	60 MB/s
LARGE	4-node Exadata RAC	12	500	12	100 MB/s



# Why is Exadata extraordinary and unique for resiliency & scalability?

Exadata and RAC – The Foundation for Platinum MAA



## Highest Availability

Engineered for zero-downtime software updates for standard outages and near-zero downtime for outages, with mitigation for severe gray failures



## Proactive Data Protection

Exadata actively detects and repairs data corruption, ensuring data integrity.

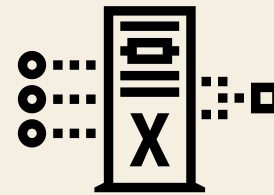

## Quality of Service

Application maintains extreme performance and low latency, adjusting dynamically when changes or issues occur



## Ongoing Health Checks

Exadata is deployed by default with integrated MAA. Exachk and health checks maintain extreme stability and availability



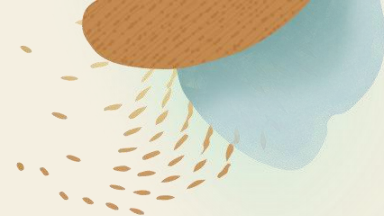

# Exadata is extraordinary and unique for resiliency & scalability

HA Use Case	Application Impact
Database Node Rolling software Update (Exadata, Grid Infrastructure and Database)	No application delay
Storage Server Rolling Software Update	No application delay
RDMA Network Fabric Switch Rolling Upgrade	10 seconds or less application delay
Hard Disk and Flash Failure	No application delay
Database Node and Instance Failure	10 seconds or less application delay
RDMA Network Fabric Switch or Port Failure	10 seconds or less application delay

Near Zero Application Impact for Most Common Planned and Unplanned Outages

Striving for Much Better!!!

## Mitigation Solutions for Toughest “Gray Failures”

Gray Failure HA Use Case	Exadata Feature and Handling
Oversubscribed Resources	Exadata leverages MS alerting, Exadata AWR Support, and Real Time Insight to proactively notify and report on resource oversubscription so it can be addressed.
RoCE network port dropped packets	Exadata leverages the Exaportmon feature to detect sick network ports and take them down if traffic is not flowing correctly
Exadata Storage Cell slow / sick flash disk and hard disk	Exadata leverages the cell side IO latency capping features to cancel IO and route to secondary partners when primary partners are very slow
I/O hang	Exadata leverages the I/O hang detection to reboot a cell when the I/O are not being serviced due to, for example a sick controller.

# Exadata extraordinary examples

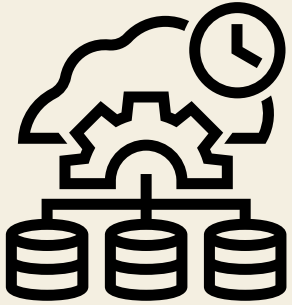

## Highest Application Availability

- 15 X Faster for Node Failure
- Only Exadata HA enables the lowest brownout



## Data Guard Redo Apply Performance

- 5-10 X Faster due to scale-out network and storage

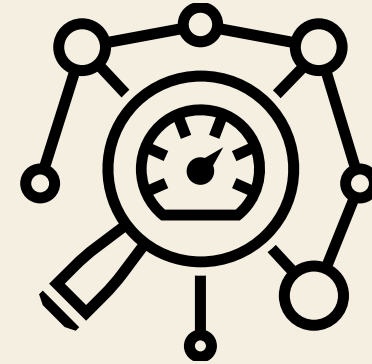

## Exadata Performance and Scalability

- 33 X better performance
- 4-10 X better OLTP latency

# DIAMOND

## Extreme Availability

### Platinum (Option 1 with GoldenGate) +

- GoldenGate 26ai Active/Active Replication
- Oracle AI Database 26ai on Exadata
- Edition-Based Redefinition compatible (optional) with GG
- MAA GGHub with Automation
  - Deployment and configuration best practices
  - ACFS failover/switchover automation

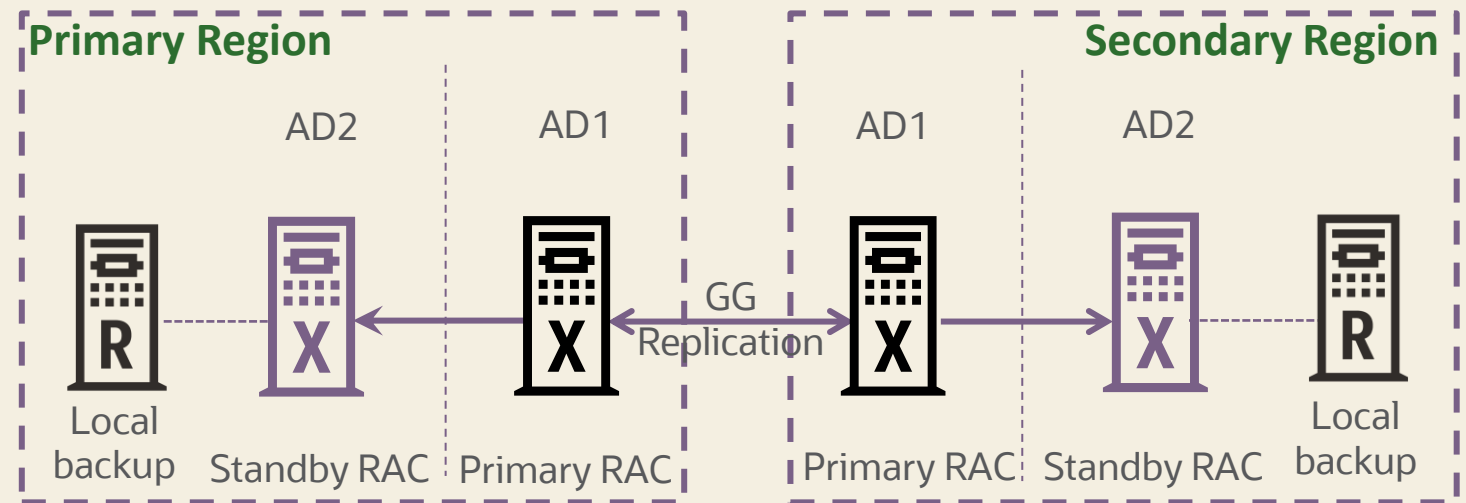

## Outage Matrix

### Unplanned Outage

### RTO/RPO Service Level Objectives (f1)

Recoverable node or instance failure	<10 secs
Disasters including corruptions and site failures	Zero. RPO zero or seconds

### Planned Maintenance

Most common software/hardware updates	Zero
Major database upgrade, <b>application upgrade</b>	Zero

f1: RPO=0 unless explicitly specified

f2: To achieve zero downtime or lowest impact, apply application checklist best practices

f3: Application failover is custom or with Global Data Services

# Diamond MAA Tier – Ideal for Extremely Mission Critical Systems

Bringing it all together

- Maximizing uptime and data protection simultaneously for both planned maintenance and unexpected outages
  - Oracle GoldenGate 26ai is required to provide an active-active platform for HA, where a simple load balancer switch allows administrators to switch workloads.
  - Oracle Active Data Guard in Oracle AI Database 26ai is providing data protection simultaneously to both primary databases, either with local or remote standby databases, depending on the data center configuration
  - Oracle Real Application Clusters provides the high availability foundation with Oracle Exadata, providing the infrastructure that maximizes the highest application availability, data protection, quality of service, and stability.
  - MAA GoldenGate Hub provides deployment and life cycle automation to ensure best practices are incorporated for streamlined replication and failover, and HA and DR for the GoldenGate Hub

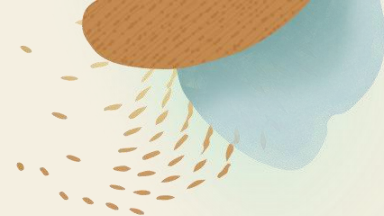

# Diamond MAA: Redundancy Throughout the Architecture

Extreme Availability Goal: Provides near-zero downtime and near-zero data loss

- **Core Components:** Architecture relies on Oracle Active Data Guard with Fast-Start Failover (FSFO) for database redundancy and MAA OGG Hub for data replication.
- **Cross-Region Placement:** The primary/active OGG Hub is co-located in the same OCI region as its target database to ensure optimal Replicat performance ( $\leq 4$  ms latency).
- **Zero Data Loss:** Achieved by configuring Data Guard with SYNC redo transport and GoldenGate resynchronization after any Data Guard failover.
- **GGHub High Availability:** Both the Primary and Standby GGHubs are configured as Active/Passive clusters, using ACFS replication to preserve all GoldenGate trail files and metadata between regions.

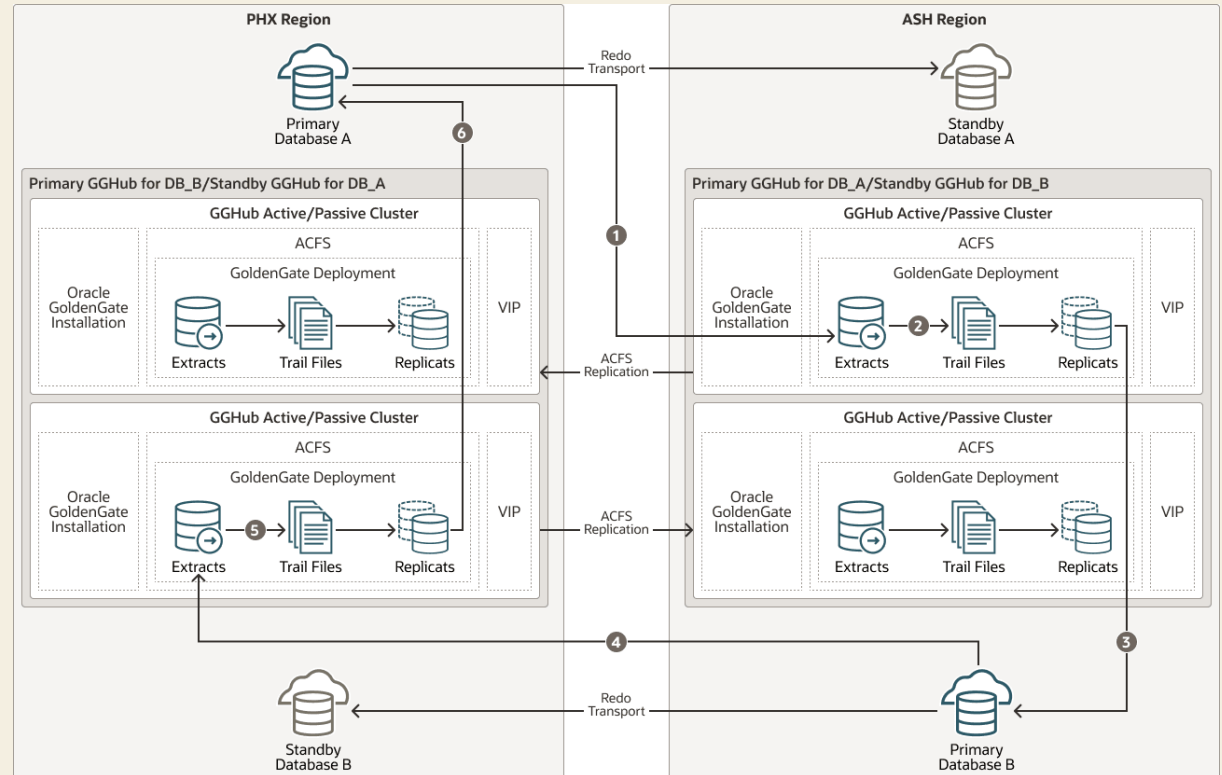



# MAA in the Cloud

—  
Maximum Availability Architecture

# Unique: Consistent Database Experience Across Deployments

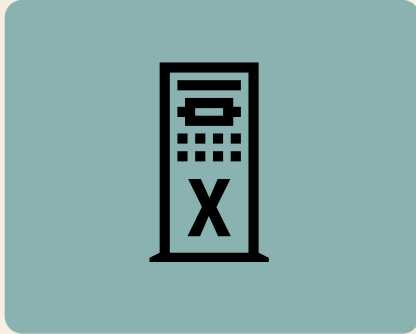

**Exadata Database Machine**  
(on-premises)



**Exadata Cloud@Customer**  
(hybrid cloud)



**Exadata Cloud Infrastructure**  
(Oracle public cloud)

**Same Oracle Database | 100% compatible | No app changes | Zero downtime migration**

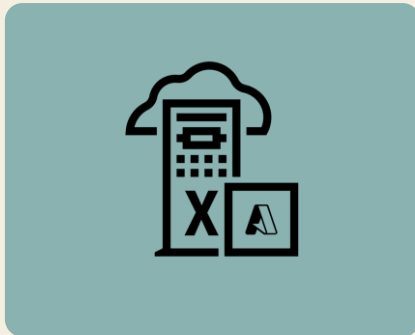

**Oracle AI Database@Azure**  
(multicloud)

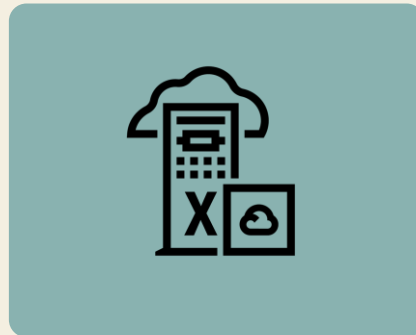

**Oracle AI Database@Google Cloud**  
(multicloud)



**Oracle AI Database@AWS**  
(multicloud)



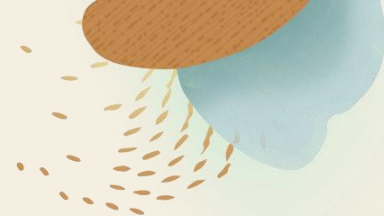

# Oracle MAA Gold for all Oracle AI Database@Hyperscalers

## Exadata Database Service on Dedicated Infrastructure

### Oracle AI Database@Azure

- ✓ MAA Silver
- ✓ MAA Gold cross-regions
- ✓ MAA Gold cross-zones

### Oracle AI Database@AWS

- ✓ MAA Silver
- ✓ MAA Gold cross-regions
- ✓ MAA Gold cross-zones

### Oracle AI Database@Google Cloud

- ✓ MAA Silver
- ✓ MAA Gold cross-regions
- MAA Gold cross-zones (in progress)

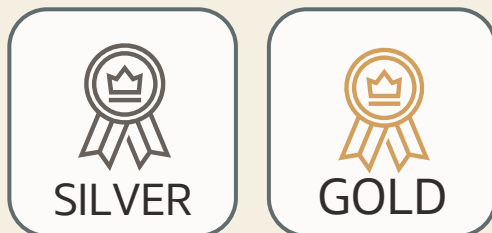

# Multiple Standby Databases in Exadata Database Service

Up to 6 standby databases can now be managed by the OCI control plane



By taking advantage of multiple standbys in different regions, applications can immediately benefit from improved data protection, increased flexibility and scalability, and better ROI

Using the new Data Guard Group feature, multiple standby databases can be easily deployed and managed via the OCI console feature

## Data Guard group

[Add standby](#)

Member	VM Cluster	Role	Region	Protection mode	Transport type	Apply lag	Transport lag	Lag as of	Data Guard type
DB1200	<a href="#">VMCluster-A</a>	Primary	US East (Ashburn)	Maximum Availability	Async	—	—	—	Data Guard
<a href="#">DB1200</a>	<a href="#">VMCluster-B</a>	Standby	US East (Ashburn)	Maximum Availability	Sync	0 seconds	0 seconds	Mon, Dec 16, 2024, 15:57:46 UTC	Data Guard
<a href="#">DB1200</a>	<a href="#">VMCluster-202404251654</a>	Standby	US East (Ashburn)	Maximum Availability	Async	0 seconds	0 seconds	Mon, Dec 16, 2024, 15:58:01 UTC	Active Data Guard
<a href="#">DB1200</a>	<a href="#">CGBCK</a>	Standby	US East (Ashburn)	Maximum Availability	Async	0 seconds	0 seconds	Mon, Dec 16, 2024, 15:58:07 UTC	Active Data Guard
<a href="#">DB1200</a>	<a href="#">VMCluster-202411184690</a>	Standby	US East (Ashburn)	Maximum Availability	Async	0 seconds	0 seconds	Mon, Dec 16, 2024, 15:58:12 UTC	Active Data Guard
<a href="#">DB1200</a>	<a href="#">VMCluster-202411184300</a>	Standby	US West (Phoenix)	Maximum Availability	Async	0 seconds	0 seconds	Mon, Dec 16, 2024, 15:58:18 UTC	Active Data Guard
<a href="#">DB1200</a>	<a href="#">VMCluster-202411184311</a>	Standby	US West (Phoenix)	Maximum Availability	Async	0 seconds	0 seconds	Mon, Dec 16, 2024, 15:58:23 UTC	Active Data Guard



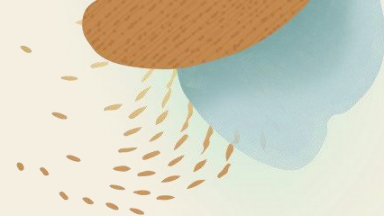

# Eliminates Site Downtime

## Oracle Autonomous Data Guard

### Maintains a real-time remote copy of a production database

- Protects from physical disasters, network outages
- Can automatically switch from primary to remote copy

### Maintains copy by applying physiological changes

- Protects against database corruption
- Validates data consistency as changes are applied

### Fully Autonomous – Automates Everything

- Creation, operation, patching, and backup
- Database and Data Guard management

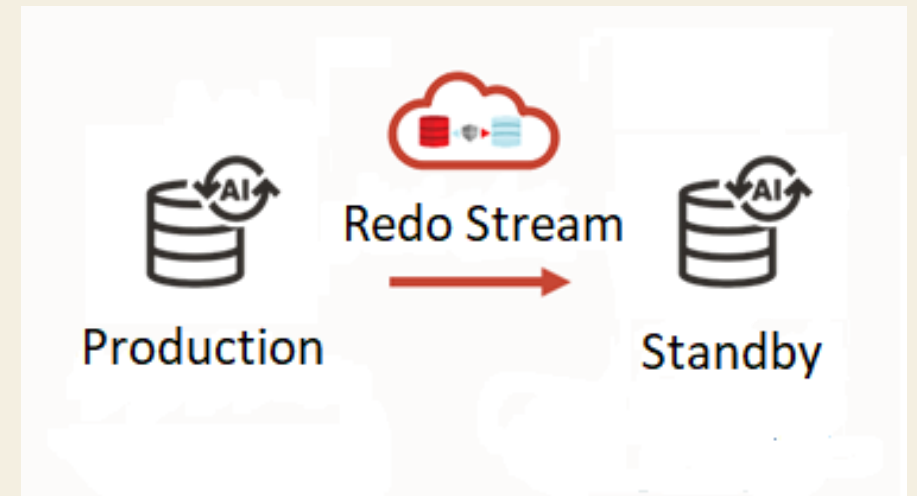



# Exadata Database Service@Hyperscaler | MAA Silver Level

## High Availability and Data Protection Built-in by Default

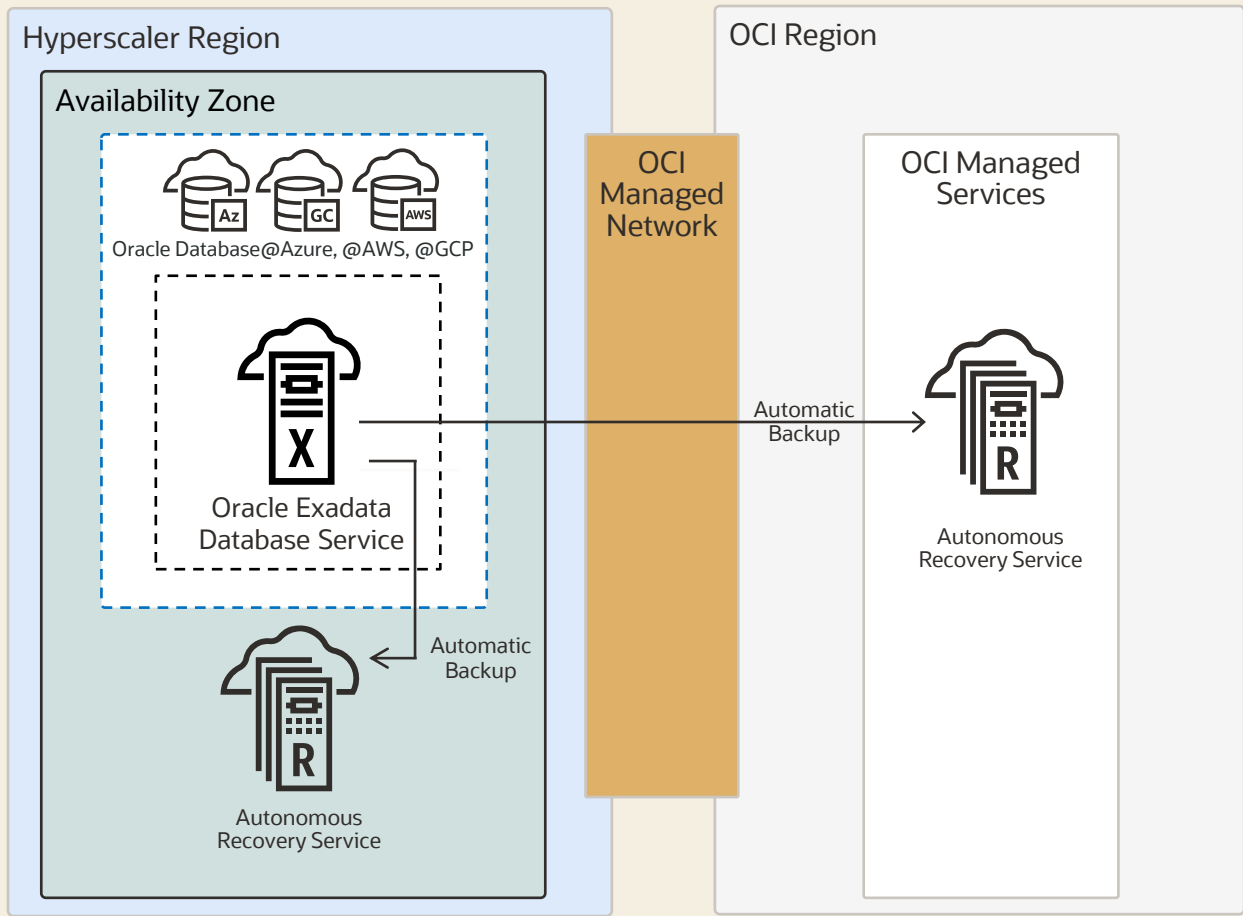

- ✓ Oracle Exadata and Oracle RAC
  - ✓ Agility to scale storage, compute, and memory without downtime
  - ✓ Node failure protection
  - ✓ Zero downtime software maintenance
- ✓ Zero Data Loss Autonomous Recovery Service
  - ✓ Available in OCI and in multicloud hyperscaler
  - ✓ One click to choose the backup destination

Store backups in the same cloud provider as the database ⓘ





# Oracle MAA Gold level cross-zones architecture

## Enhancing availability and ensuring zero data loss

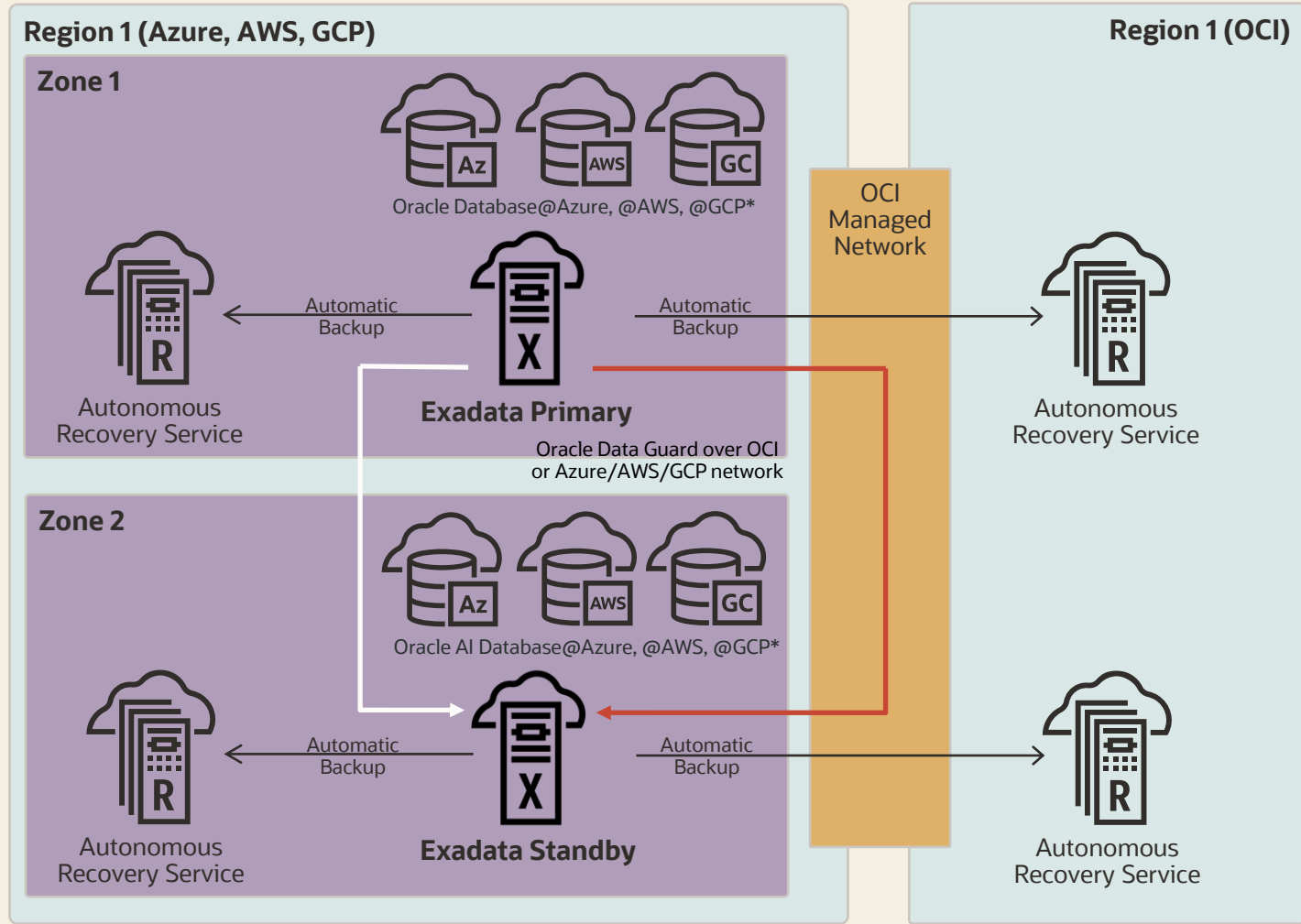

### MAA Silver Level +

- ✓ Site failure protection
- ✓ Oracle Data Guard's In-Memory replication with zero data loss
- ✓ Minimal performance impact

### + Active Data Guard

- ✓ Comprehensive data corruption prevention
- ✓ Offload read-mostly workloads to the standby
- ✓ Online updates

### + Multiple Standbys

- ✓ Read-mostly scale-out

\*MAA cross-zones certification for GCP in progress





# Oracle MAA Gold level multi-region architecture

## Safeguarding continuous availability and real-time data protection

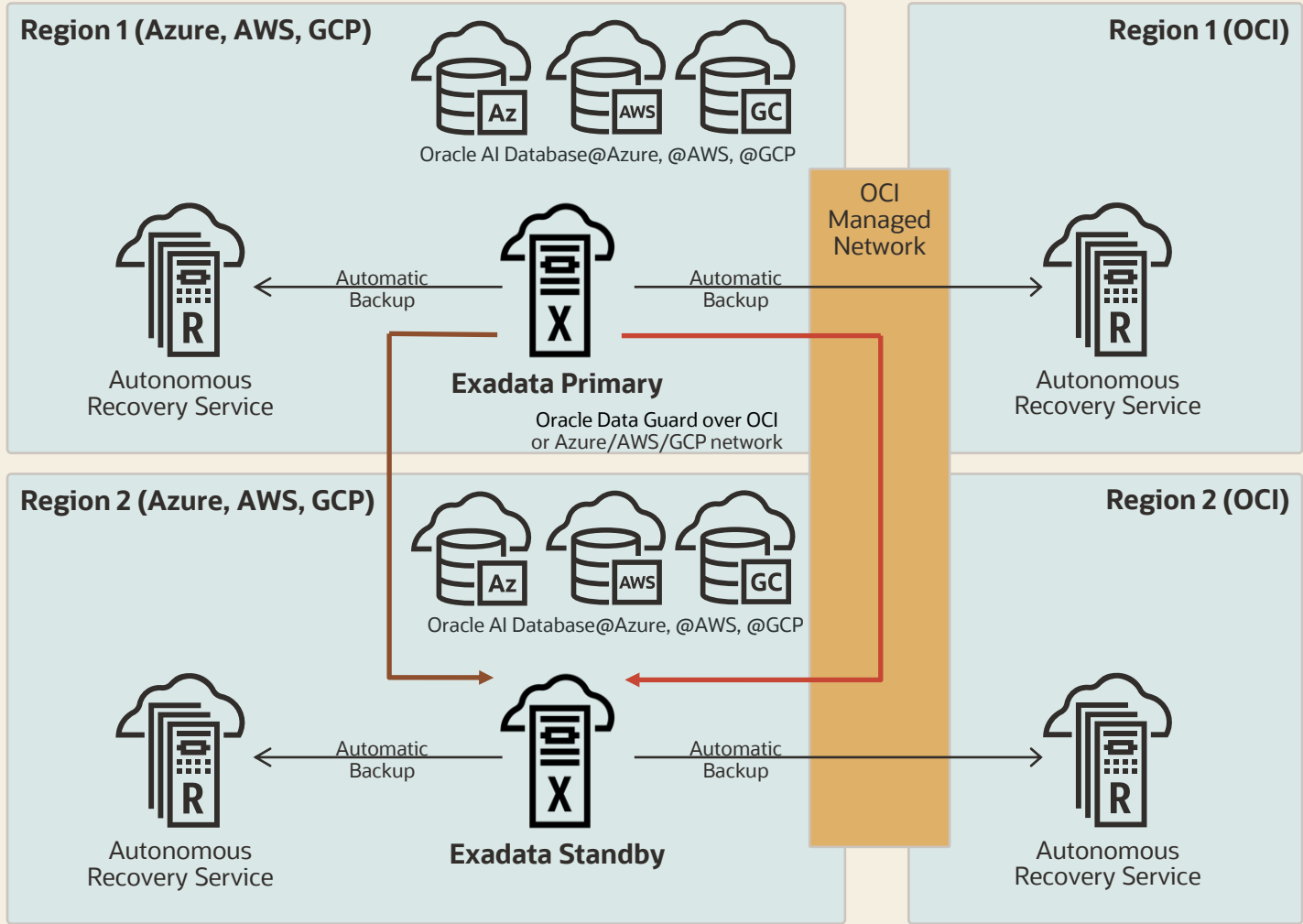

MAA Silver Level +

- ✓ Regional disaster recovery protection
- ✓ Oracle Data Guard's In-Memory replication with (near) zero data loss
- ✓ No performance impact

+ Active Data Guard

- ✓ Comprehensive data corruption prevention
- ✓ Offload read-mostly workloads to the standby
- ✓ Online updates

+ Multiple Standbys

- ✓ Zero data loss across regions with minimal impact on primary performance
- ✓ Read-mostly scale-out





# Orchestrate end-to-end recovery with Full Stack DR

Available for the full stack in OCI, and for multicloud databases

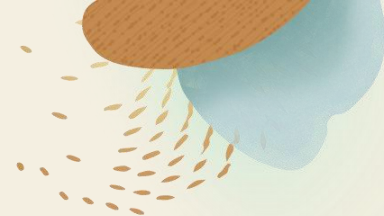

Fully-managed disaster recovery (DR) service providing

- **DR for the entire application stack**
  - Orchestrated single-click DR for infrastructure, applications & databases
- **Automated DR plan creation**
  - Reduced time and effort to create and manage disaster recovery plans
- **Unified management**
  - Validated and monitored execution of DR plans through an integrated UI / API

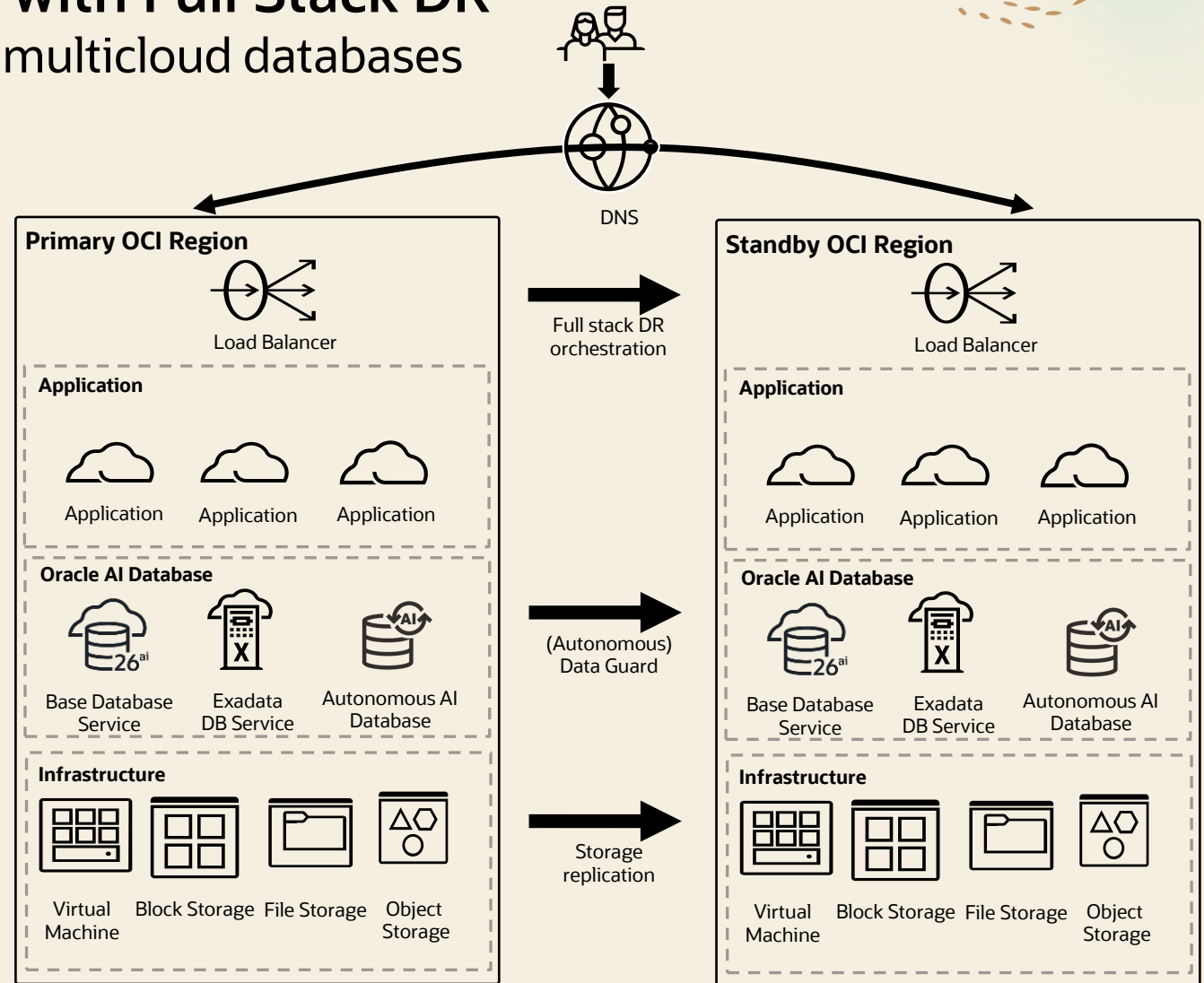

# Zero Data Loss Autonomous Recovery Service (ZRCV)

Intelligent data protection for Oracle AI Databases in OCI, Multicloud, & On-premises

## Zero Data Loss Recovery

- Real-time transaction protection
- Continuous recovery validation

## Fast, Low-Impact Backup and Recovery

- Space-efficient incremental forever
- One-step recovery without needing incremental apply

## Database-aware Ransomware Resiliency

- Immutable backups with retention lock
- Separation of duties and granular access control
- Logical airgap between the customer and Oracle Cloud Operations tenancies
- Cross-domain and cross-region clean room support

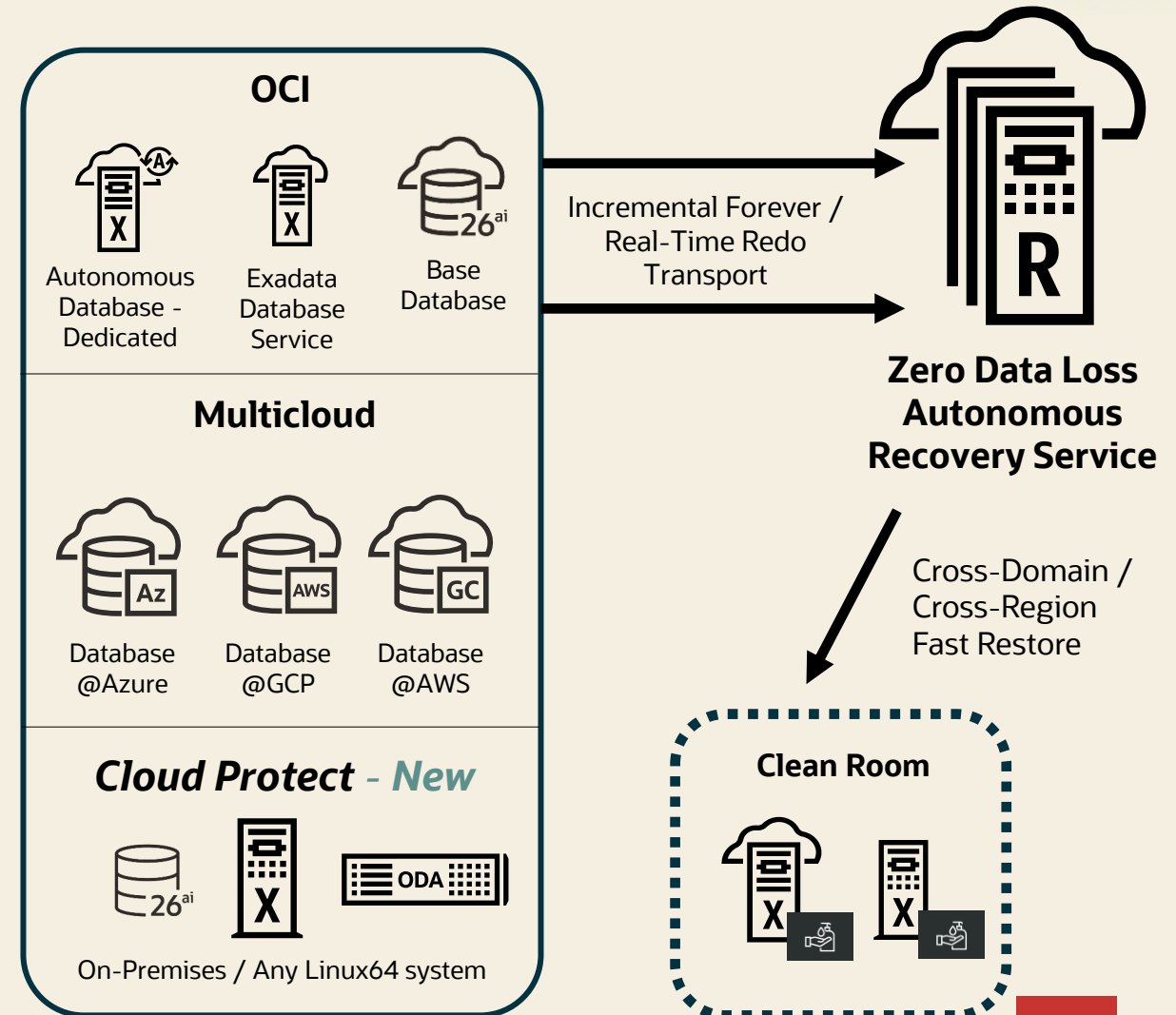

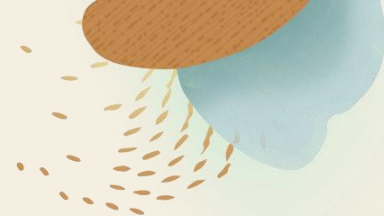

# Hybrid Cloud: Recommended Hybrid Sources/Destinations

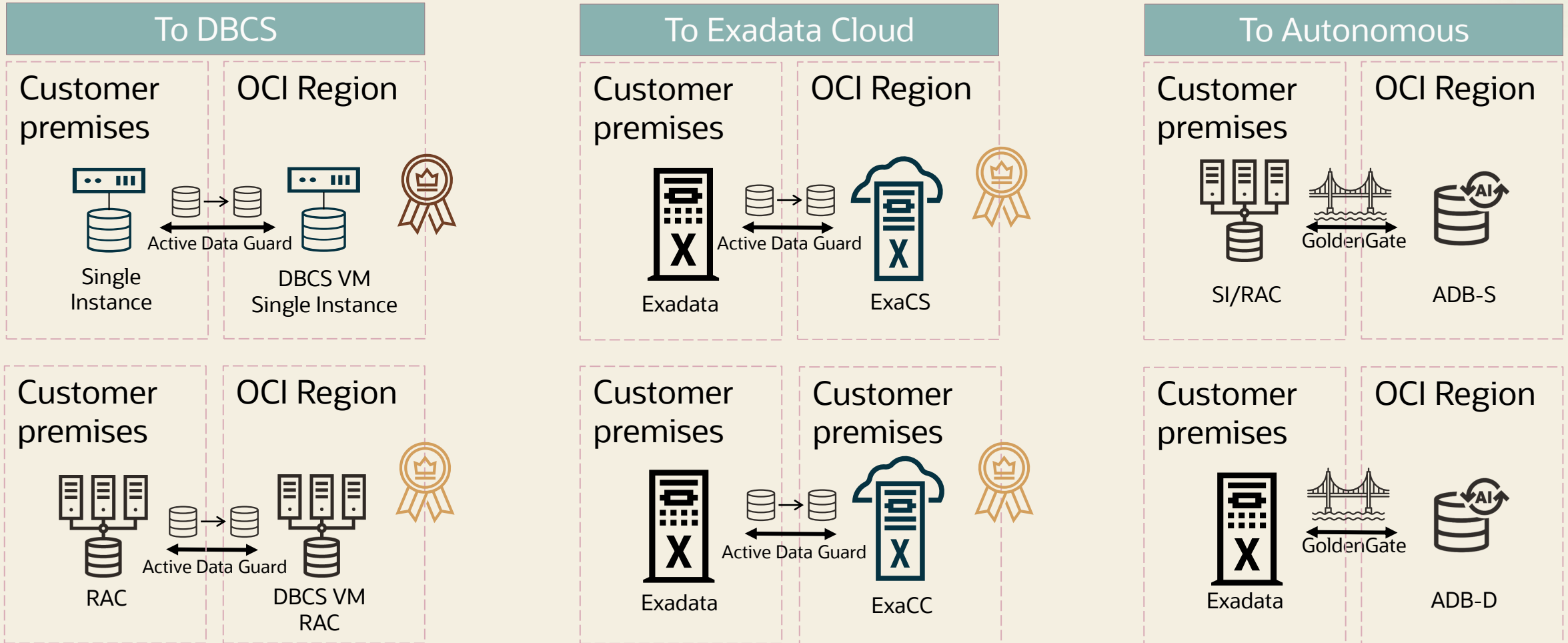

- All Hybrid configurations are achieved manually: no Control Plane automation
- On-premises non-Exadata to ExaCC/ExaCS is possible but beware of exclusive features



# Key Takeaways

Oracle AI Database High Availability and Disaster Recovery technology provides:

- MAA reliability that has evolved over 20 years, deployed by thousands of customers
- Flexible high availability and disaster recovery for the application with no modification
- Zero data loss is an option regardless of distance
- Rolling patching provides zero downtime during the most common planned maintenance operations
- On-demand, reliable, and fully elastic





## Maximum Availability Architecture

- MAA Home:
  - <http://oracle.com/goto/maa>
- On-Premises MAA:
  - <https://www.oracle.com/database/technologies/high-availability/oracle-database-maa-best-practices.html>
- Exadata MAA:
  - <https://www.oracle.com/database/technologies/high-availability/exadata-maa-best-practices.html>
- Cloud MAA:
  - <https://www.oracle.com/database/technologies/high-availability/oracle-cloud-maa.html>

ORACLE